

# INSTRUCTION MANUAL

## 1/10TH SCALE 4WD ELECTRIC POWER RADIO CONTROLLED VEHICLES

Number	Description
<b>A1</b>	<b>On-road Car</b>
<b>A2</b>	<b>Pro .On-road Car</b>
<b>B1</b>	<b>Off-road Buggy</b>
<b>B2</b>	<b>Pro .Off-road Buggy</b>
<b>C1</b>	<b>Off-road Truck</b>
<b>C2</b>	<b>Pro .Off-road Truck</b>
<b>D1</b>	<b>Off-road Truggy(1)</b>
<b>D2</b>	<b>Pro .Off-road Truggy(1)</b>
<b>E1</b>	<b>On-road Drift Car</b>
<b>E2</b>	<b>Pro .On-road Drift Car</b>
<b>F1</b>	<b>Off-road Truggy(2)</b>
<b>F2</b>	<b>Pro .Off-road Truggy(2)</b>
<b>G</b>	<b>Off-road ATV</b>
<b>H1</b>	<b>Rally Monster</b>
<b>H2</b>	<b>Pro .Rally Monster</b>



In order to understand our company products more expediently, please check it according to the part number.

**Electric power models** went quite popular nowadays and attracted more and more operators. We manufactured a series of 1/10 electric power models and many high quality aluminum parts.

### Notes:

- ⇒ Read and understand the instructions carefully before operating or assembling your racing model.
- ⇒ Specifications are subject to change without prior notice, and actual received model may vary from the images and/or descriptions in this manual.

**NEW**

	KV(Brushless Motor)	RPM(Brushless Motor)	Max output for brushless ESC	Output Current	Voltage Input for ESC	ESC Temperature protection	Under Voltage Protection	NI-MH Battery	Lipo Battery	Gear Ratio	Speed
A2 Off-road car	★ 3300KV	23760rpm	540W/60sec	75A	NI-MH Battery 7.2V	98. (+/-3-5 centigrade)	On/below 5V 1A	★ 2000mAh		26T/58T	45KM
	4000KV	28800rpm	540W/60sec	75A	NI-MH Battery 7.2V	98. (+/-3-5 centigrade)	On/below 5V 1A	2000-4500mAh		26T/58T	50KM
	4000KV	28800rpm	540W/60sec	75A	NI-MH Battery 7.2V	98. (+/-3-5 centigrade)	On/below 5V 1A	2000-4500mAh		29T/58T	55KM
	3300KV	27720rpm	540W/60sec	75A	NI-MH Battery 8.4V	98. (+/-3-5 centigrade)	On/below 5.5V 1A	3000-4500mAh		29T/58T	55KM
B2 Off-road Buggy	4000KV	29600rpm	540W/60sec	75A	Lipo Battery 7.4V	98. (+/-3-5 centigrade)	On/below 5V 1A		3500-4500mAh	26T/58T	55KM
	4000KV	29600rpm	540W/60sec	75A	Lipo Battery 7.4V	98. (+/-3-5 centigrade)	On/below 5V 1A		3500-4500mAh	29T/58T	60KM
	2600KV-2800KV	28860rpm-31080rpm	540W/60sec	75A	Lipo Battery 11.1V	98. (+/-3-5 centigrade)	On/below 7.2V 1A		4000-5000mAh	29T/58T	70KM
	★ 3300KV	23760rpm	540W/60sec	75A	NI-MH Battery 7.2V	98. (+/-3-5 centigrade)	On/below 5V 1A	★ 2000mAh		23T/64T	45KM
H2 Rally Monster	4000KV	28800rpm	540W/60sec	75A	NI-MH Battery 7.2V	98. (+/-3-5 centigrade)	On/below 5V 1A	★ 2000mAh		23T/64T	45KM
	3300KV	27720rpm	540W/60sec	75A	NI-MH Battery 8.4V	98. (+/-3-5 centigrade)	On/below 5.5V 1A	2000-4500mAh		26T/64T	55KM
	3300KV	27720rpm	540W/60sec	75A	NI-MH Battery 8.4V	98. (+/-3-5 centigrade)	On/below 5.5V 1A	3000-4500mAh		29T/64T	60KM
	4000KV	29600rpm	540W/60sec	75A	Lipo Battery 7.4V	98. (+/-3-5 centigrade)	On/below 5V 1A		3500-4500mAh	29T/64T	70KM
D2&F2 Off-road Truggy	2600KV-2800KV	28860rpm-31080rpm	540W/60sec	75A	Lipo Battery 11.1V	98. (+/-3-5 centigrade)	On/below 7.2V 1A		4000-5000mAh	29T/64T	75KM
	★ 3300KV	23760rpm	540W/60sec	75A	NI-MH Battery 7.2V	98. (+/-3-5 centigrade)	On/below 5V 1A	★ 2000mAh		18T/64T	45KM
	3300KV	23760rpm	540W/60sec	75A	NI-MH Battery 7.2V	98. (+/-3-5 centigrade)	On/below 5V 1A	2000-4500mAh		23T/64T	50KM
	3300KV	27720rpm	540W/60sec	75A	NI-MH Battery 8.4V	98. (+/-3-5 centigrade)	On/below 5.5V 1A	3000-4500mAh		23T/64T	55KM
C2 Off-road truck	3300KV	24420rpm	540W/60sec	75A	Lipo Battery 7.4V	98. (+/-3-5 centigrade)	On/below 5V 1A		3500-4500mAh	23T/64T	55KM
	★ 3300KV	23760rpm	540W/60sec	75A	NI-MH Battery 7.2V	98. (+/-3-5 centigrade)	On/below 5V 1A	★ 2000mAh		17T/64T	45KM
	3300KV	23760rpm	540W/60sec	75A	NI-MH Battery 7.2V	98. (+/-3-5 centigrade)	On/below 5V 1A	2000-4500mAh		21T/64T	50KM
	3300KV	27720rpm	540W/60sec	75A	NI-MH Battery 8.4V	98. (+/-3-5 centigrade)	On/below 5.5V 1A	3000-4500mAh		21T/64T	55KM
	3300KV	24420rpm	540W/60sec	75A	Lipo Battery 7.4V	98. (+/-3-5 centigrade)	On/below 5V 1A		3500-4500mAh	21T/64T	55KM

**ATTENTION:**

1. To reach the speed which the data sheet mentioned as up, the motor and ESC Surface temperature can not over 75°C.
2. The situation of the ESC undervoltage protection as below: a. The models obvious decrease the speed. b. The LED1 & LED2 light of ESC not bright or Scintillation, can not on work normally. C. There is the sounds "di,di,di" from motor, can not on work normally.
3. Selected our upgrade kit to improve the speed higher than the data sheet mentioned as up.

**1/10th brushless ESC(#03307) Data**

Voltage Input	Switching Frequency	Max Output	Max Output Current	Coutinuous Forward Current	Coutinuous Backward Current	Temperature Protection	Under Voltage Protection	NI-MH Battery	Lipo Battery
NI-MH Battery 7.2V	31KHZ	540W/60sec	75A	5min/75A	5min/75A	98. (+/-3-5 centigrade)	On/below 5V 1A	7.2V 2000-4500mAh	
NI-MH Battery 8.4V				30sec/95A	30sec/95A		On/below 5.5V 1A	8.4V 3000-4500mAh	
Lipo Battery 7.4V				1sec/150A	1sec/150A		On/below 5V 1A	7.4V 3500-4500mAh	
Lipo Battery 11.1V							On/below 7.2V 1A	11.1V 4000-5000mAh	

**1/10th brushless Motor(#03302) Data**

Brushless Motor Model	KV	RPM range	Coutinuous Forward Current	Coutinuous Backward Current	NI-MH Battery	Lipo Battery
3650(540L)	4000KV	28800rpm	5min/75A	5min/75A	7.2V 2000-4000mAh	
	3300KV	27720rpm	30sec/95A	30sec/95A	8.4V 3000-4500mAh	
	3300KV	24420rpm	1sec/150A	1sec/150A	7.4V 3500-4500mAh	
	2200KV	24420rpm			11.1V 4000-5000mAh	

**ATTENTION:**

1. The Charger could have an accident that it is more than 12 hours.

ITEM NO.	MODEL NO.	STYLES	LENGTH	WIDTH	HEIGHT	WHEEL BASE	DRIVE SYSTEM	GEAR RATIO	GROUND CLEARANCE	DIAMETER OF WHEEL	WIDTH OF WHEEL	MOTOR	ESC	BATTERY
A1	94103	on-road car	360mm	200mm	112mm	260mm	4WD Shaft Drive	6.52:1	4.5mm	65mm	26mm	Rc540	Sp03018	7.2V,1800mAh NI-MH
A2	94103Pro	Pro. on-road car	400mm	380mm	112mm	260mm	4WD Shaft Drive	6.52:1	4.5mm	65mm	26mm	Brushless 3300KV	Brushless 75A	7.2V,2000mAh NI-MH
B1	94107	off-road buggy	400mm	250mm	160mm	275mm	4WD Shaft Drive	8.133:1	26mm	86mm	32mm(F) 40mm(R)	Rc540	Sp03018	7.2V,1800mAh NI-MH
B2	94107Pro	Pro. off-road buggy	400mm	250mm	160mm	275mm	4WD Shaft Drive	8.133:1	26mm	86mm	32mm(F) 40mm(R)	Brushless 3300KV	Brushless 75A	7.2V,2000mAh NI-MH
C1	94111/116 /117/121	off-road truck	400mm	310mm	185mm	275mm	4WD Shaft Drive	11:1	32mm	118mm	52mm	Rc540	Sp03018	7.2V,1800mAh NI-MH
C2	94111Pro	Pro. off-road truck	400mm	310mm	185mm	275mm	4WD Shaft Drive	11:1	32mm	118mm	52mm	Brushless 3300KV	Brushless 75A	7.2V,2000mAh NI-MH
D1	94115	off-road truggy(1)	400mm	300mm	160mm	275mm	4WD Shaft Drive	10.3:1	35mm	105mm	60mm	Rc540	Sp03018	7.2V,1800mAh NI-MH
D2	94115Pro	Pro. off-road truggy(1)	400mm	300mm	160mm	275mm	4WD Shaft Drive	10.3:1	35mm	105mm	60mm	Brushless 3300KV	Brushless 75A	7.2V,2000mAh NI-MH
E1	94123	on-road Drift car	360mm	200mm	112mm	260mm	4WD Shaft Drive	6.52:1	4.5mm	65mm	26mm	Rc540	Sp03018	7.2V,1800mAh NI-MH
E2	94123Pro	Pro. on-road Drift car	360mm	200mm	112mm	260mm	4WD Shaft Drive	6.52:1	4.5mm	65mm	26mm	Brushless 3300KV	Brushless 75A	7.2V,2000mAh NI-MH
F1	94124	off-road truggy(2)	400mm	320mm	160mm	275mm	4WD Shaft Drive	8.133:1	26mm	86mm	32mm(F) 40mm(R)	Rc540	Sp03018	7.2V,1800mAh NI-MH
F2	94124Pro	Pro. off-road truggy(2)	400mm	320mm	160mm	275mm	4WD Shaft Drive	8.133:1	26mm	86mm	32mm(F) 40mm(R)	Brushless 3300KV	Brushless 75A	7.2V,2000mAh NI-MH
G	94112	off-road ATV	400mm	300mm	160mm	275mm	4WD Shaft Drive	10.3:1	35mm	105mm	60mm	Rc540	Sp03018	7.2V,1800mAh NI-MH
H1	94170	rally monster	460mm	250mm	160mm	275mm	4WD Shaft Drive	8.038:1	26mm	86mm	42mm	Rc540	Sp03018	7.2V,1800mAh NI-MH
H2	94170Pro	Pro. rally monster	460mm	250mm	160mm	275mm	4WD Shaft Drive	8.038:1	26mm	86mm	42mm	Brushless 3300KV	Brushless 75A	7.2V,2000mAh NI-MH

## Features

**A1**

- 1/10th scale on-road racing car tyres feature quick on-road running performance and durable service time.
- High precision electronic speed control(SP03018) is mounted.
- Long rear body post with many holes is perfect for adjusting vehicle body level.
- Good quality oil filled on-road racing car shock absorber
- Extra large high quality front provides protection against impacts.
- Solid chassis features good performance.
- Extra large radio tray provides good stability for radio system.

---

**A2**

- New Designed Brushless Motor
- New Designed Brushless ESC(#03307)
- Full Aluminum On Road Shock Sets.
- High Quality Durable Rechargeable Ni-MH Battery Pack(7.2V,1800mAh)
- Chrome Plated Wheel Rims With Colour Sprayed.

---

**B1**

- High quality 1/10th scale off-road buggy tyres provide high off-road running performance and durable service time.
- Good quality motor RC540 is applied with motor heat proof cover.
- Stylish 1/10th buggy wing
- Buggy front bumper provides protection against impacts.
- Oil filled off-road buggy shock absorber feature high shock resistance.
- Solid wing stay and holder provide good stability of wing.
- Solid chassis features good performance.
- Extra large radio tray provides stable installment of radio system.

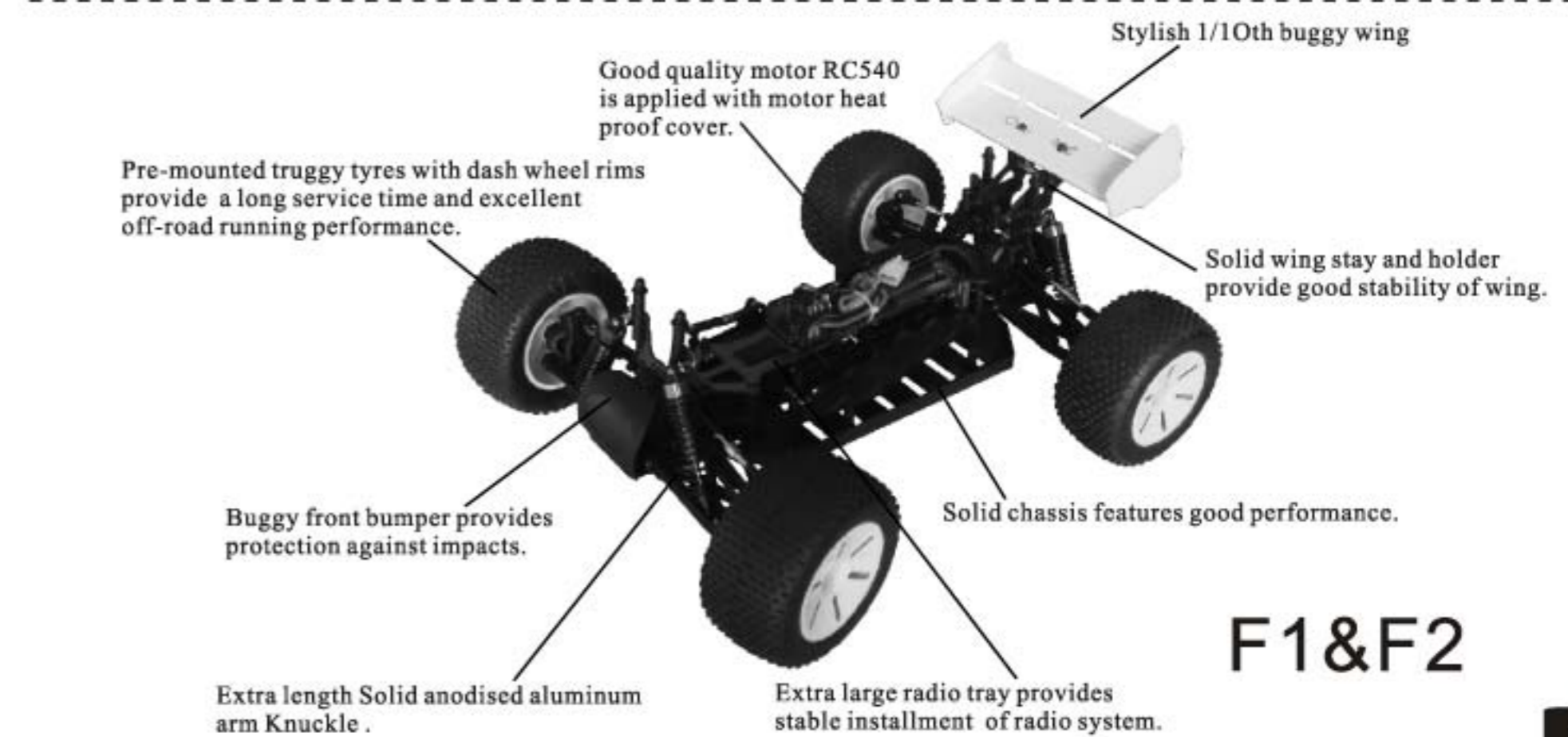
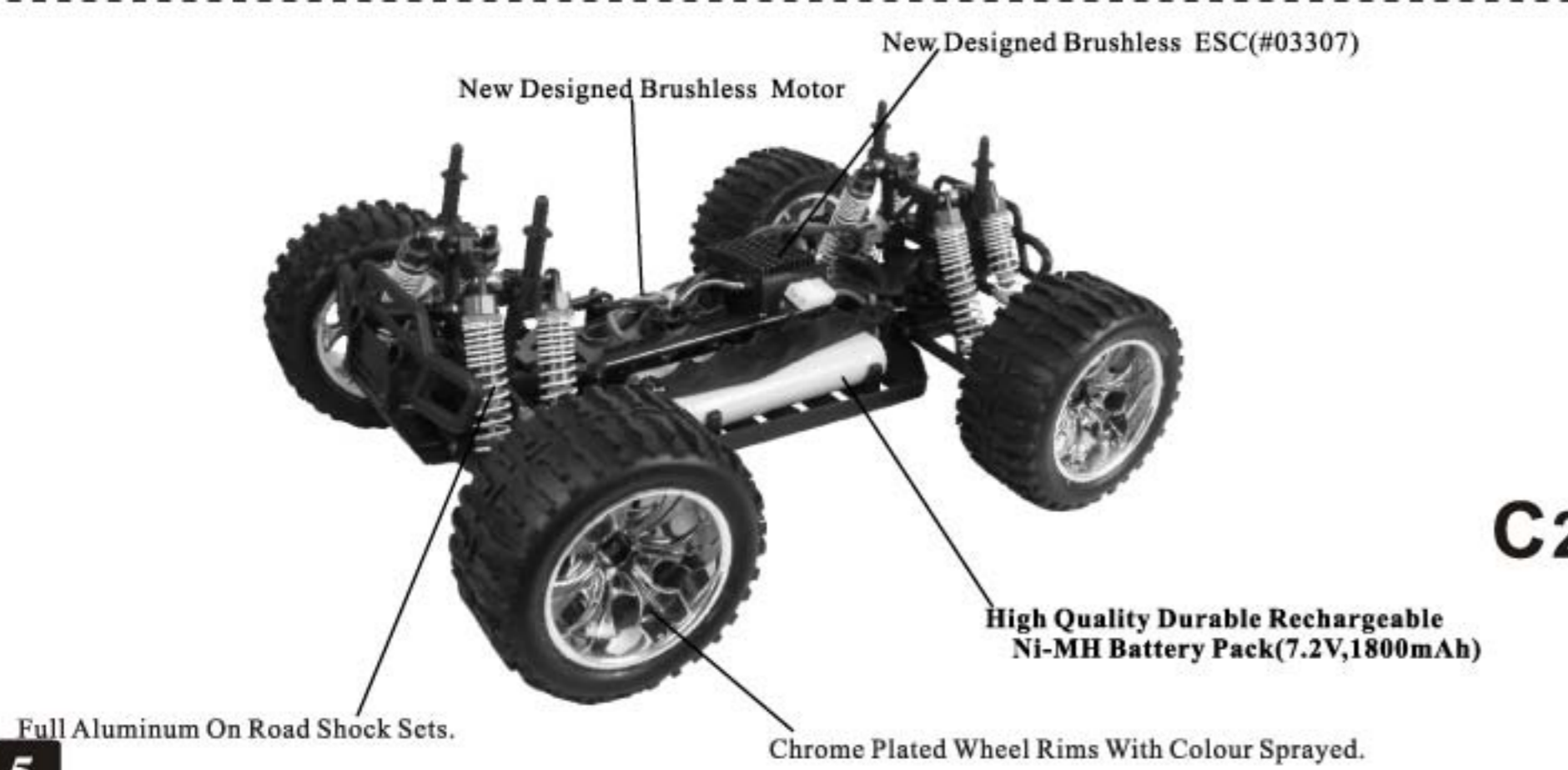
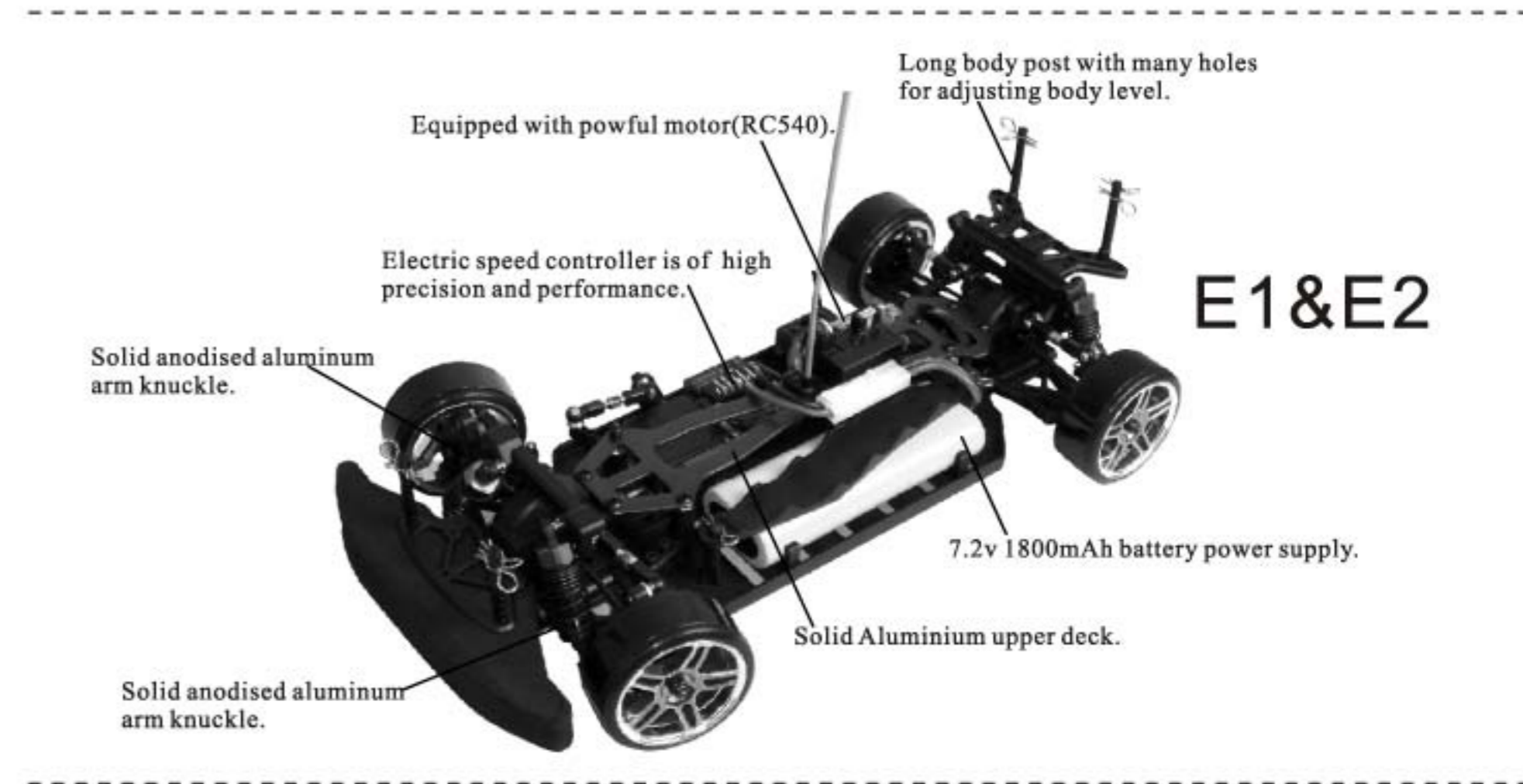
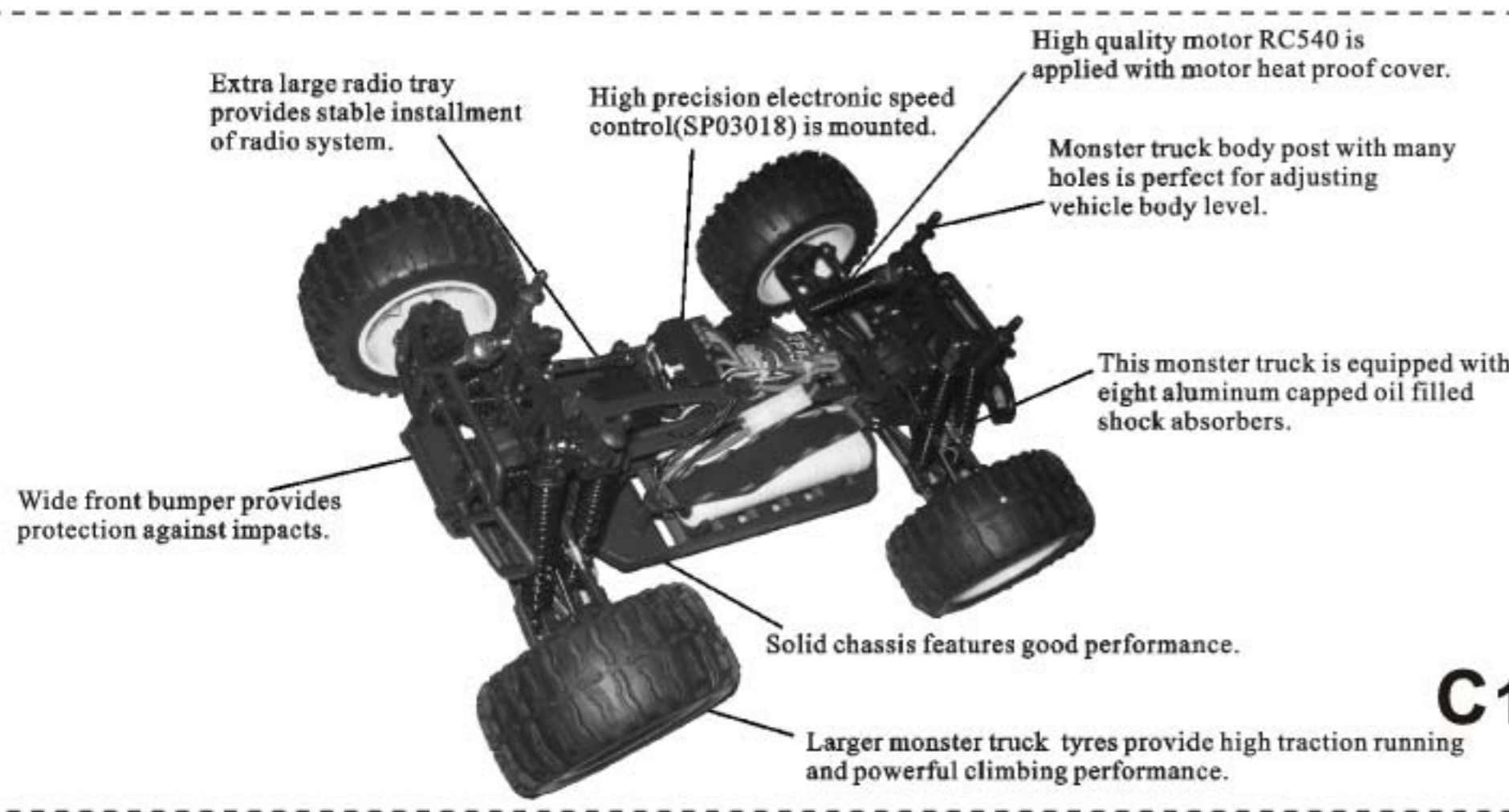
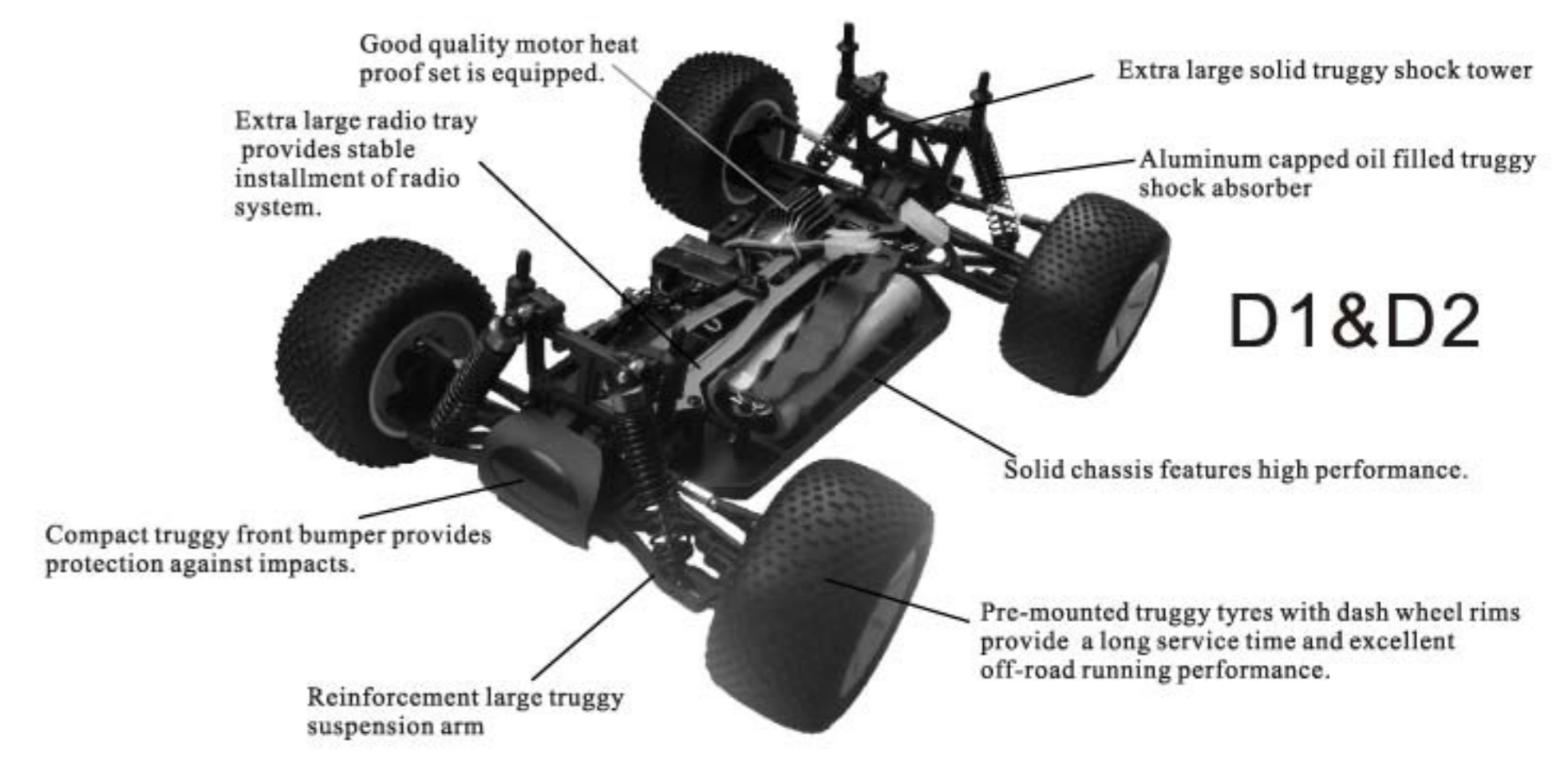
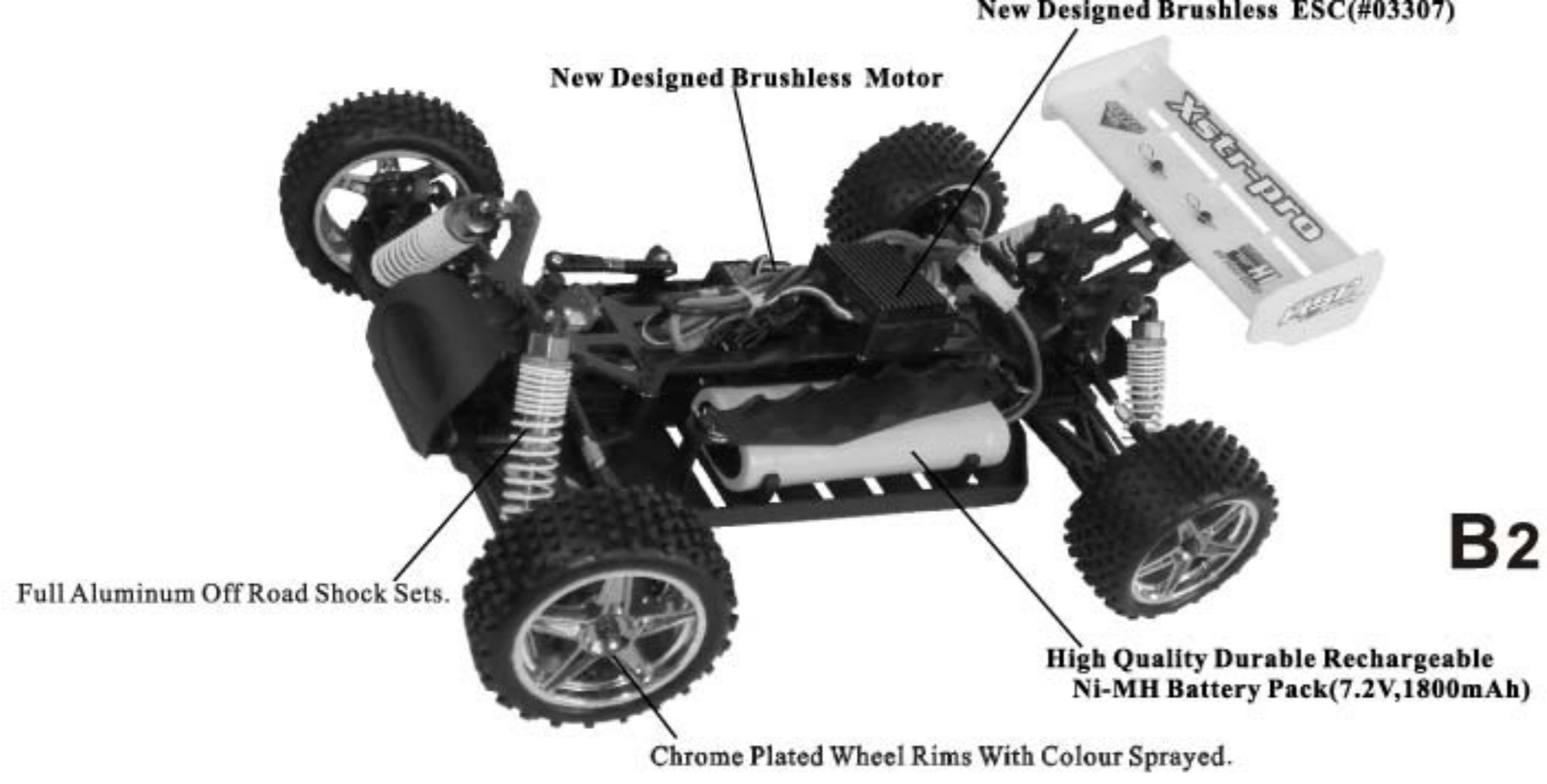

# NOTICE FOR ASSEMBLY



## Additional Items Needed For Running Your Model

The following items, not included in the kit unless specified, are required for assembling your model. These items are available in local hobby shops.

Read and understand all instructions carefully before assembling your vehicle.

## Tools Needed To Maintain Your Model

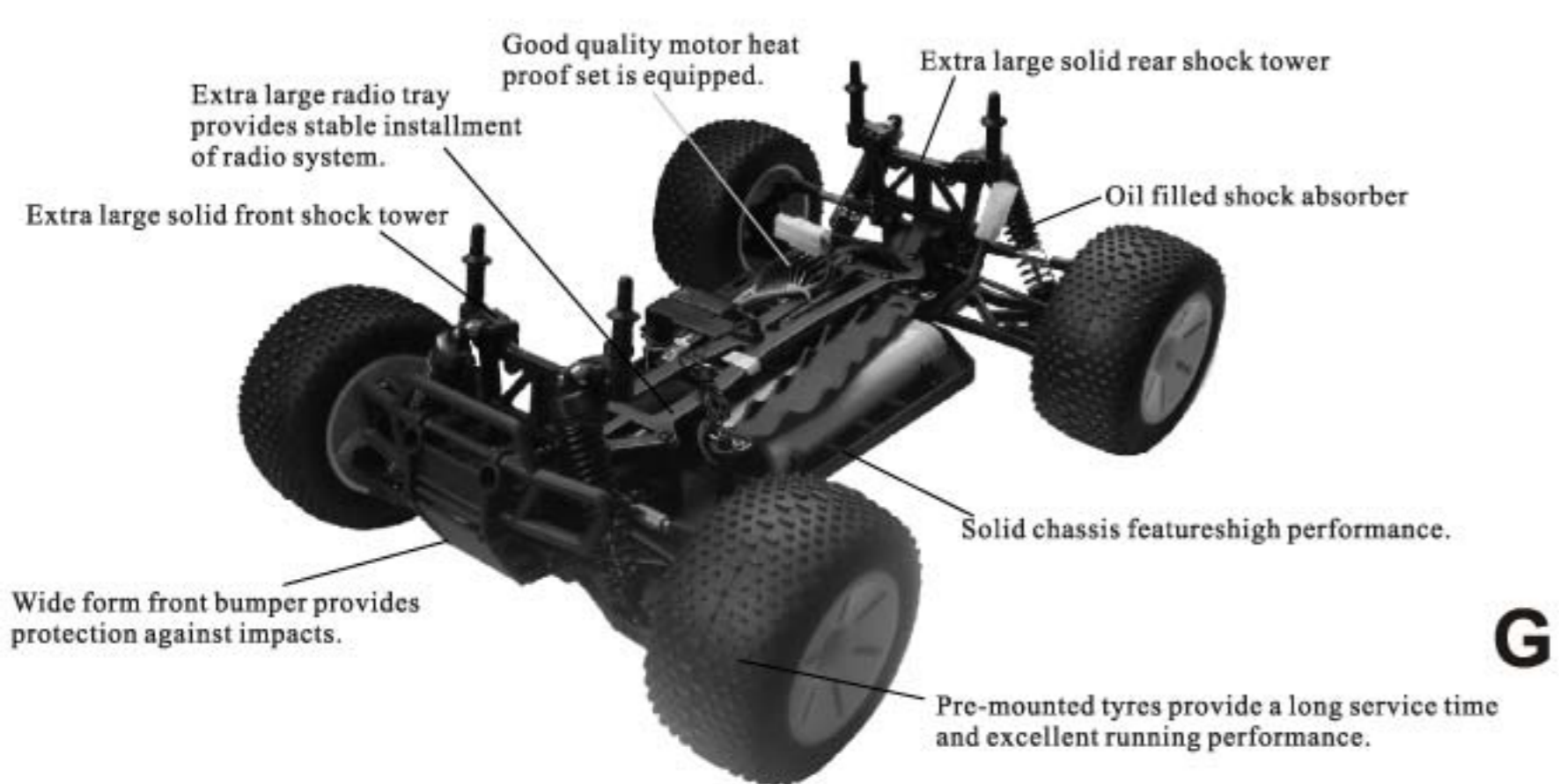
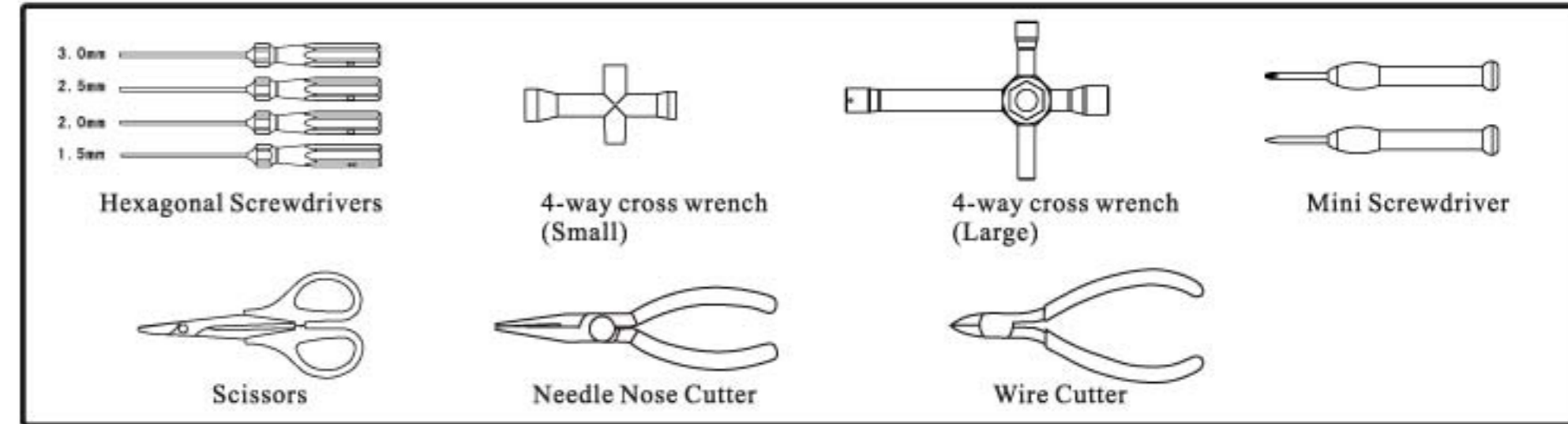

**G**

### Body Required:

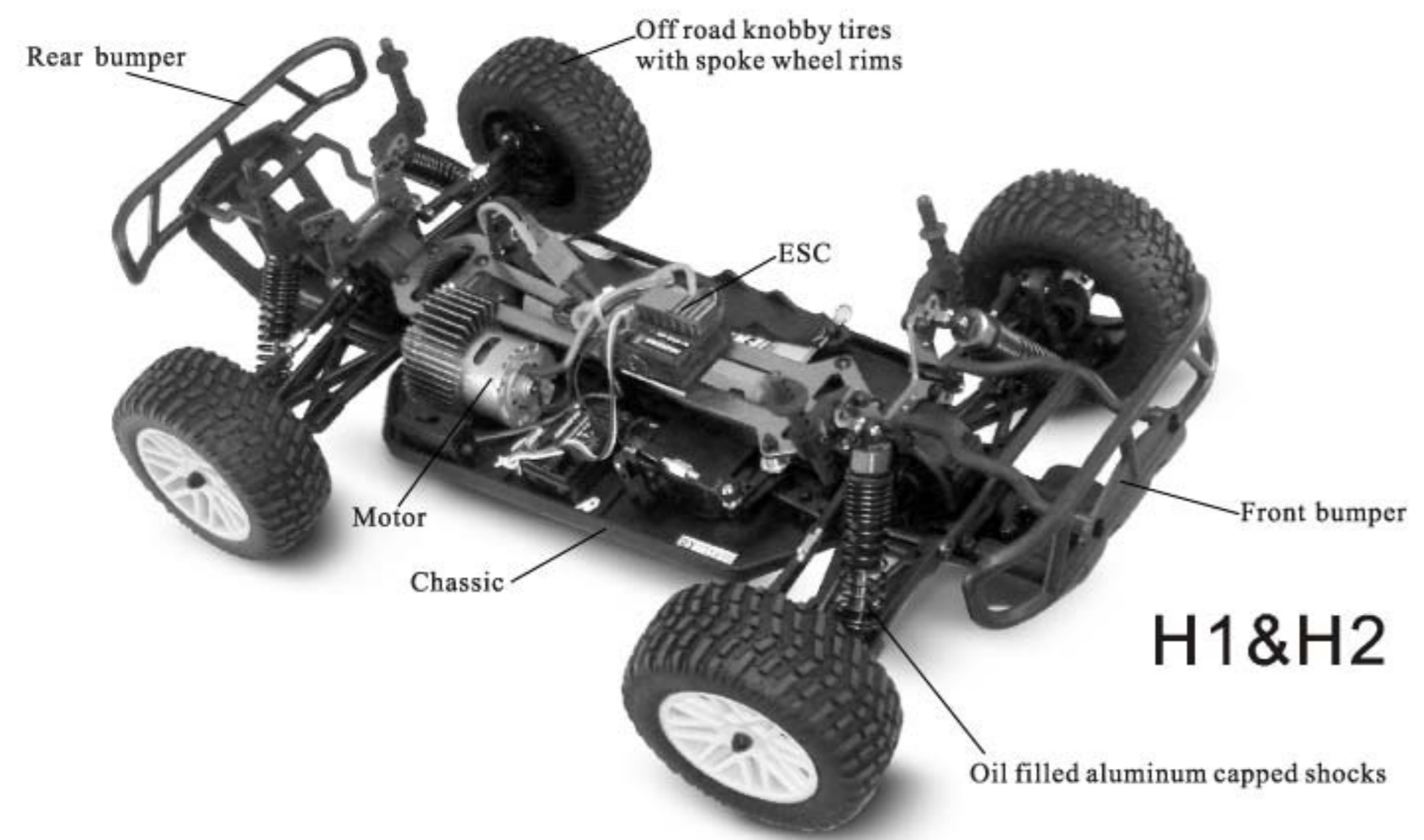
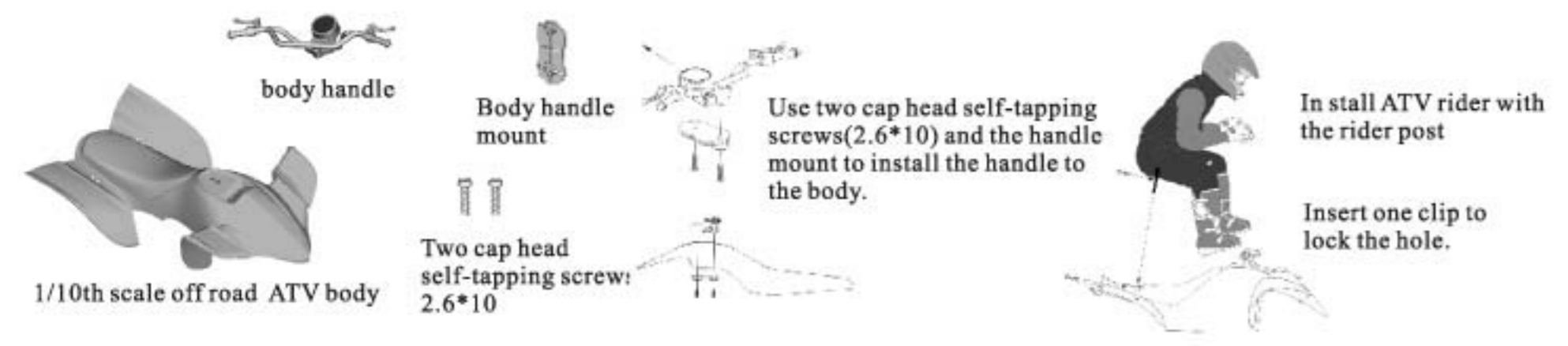

**H1&H2**

## Use of the transmitter to control your EP vehicle...

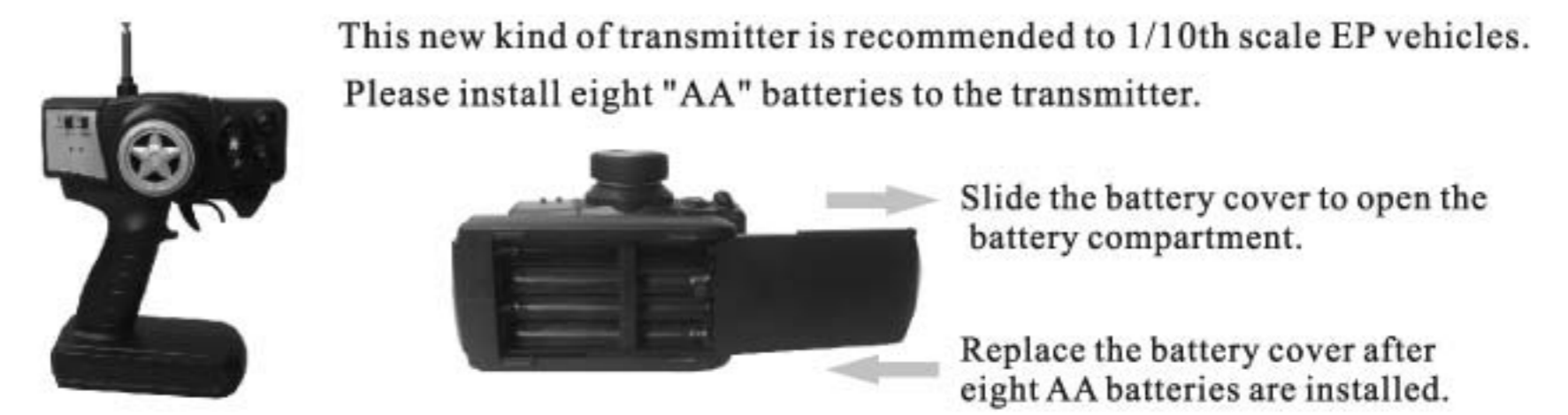

## Battery Precautions:

1. In order to maintain good performance, we warmly recommend you to use the 1.5V alkaline batteries instead of the 1.2 V chargeable batteries.
2. The batteries may leak in the event that they are installed with wrong polarities.
3. Do not use batteries of different types.
4. Do not mix the old and new batteries.
5. Do not leave batteries if not in use for a long period.
6. Please replace batteries when power indicators are weak.

## Function Switches On This Transmitter



1. Throttle Reverse Switch
2. Steering Reverse Switch
3. Control Wheel
4. Steering Trim
5. Throttle Trim
6. Trigger
7. Crystal (To change please pull out)
8. Power Indicators
9. Trigger Setup Trim
10. Power Switch

## How to drive forward, stop(break), and backward

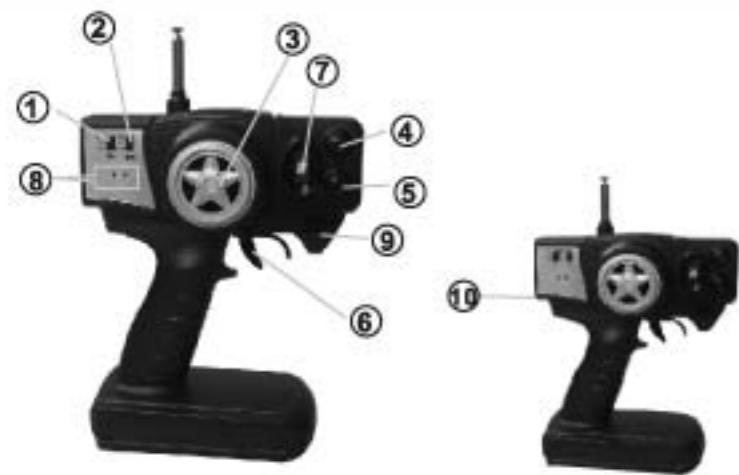

- |                           |                                      |
|---------------------------|--------------------------------------|
| 1.Throttle Reverse Switch | 6.Trigger                            |
| 2.Steering Reverse Switch | 7.Crystal(To change please pull out) |
| 3.Control Wheel           | 8.Power Indicators                   |
| 4.Steering Trim           | 9.Trigger Setup Trim                 |
| 5.Throttle Trim           | 10.Power Switch                      |

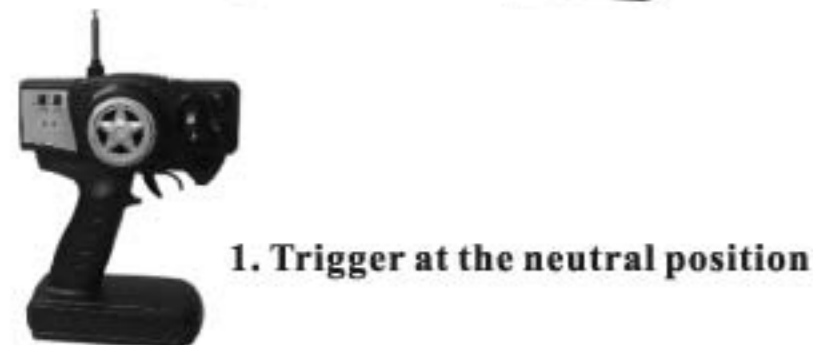

1. Trigger at the neutral position

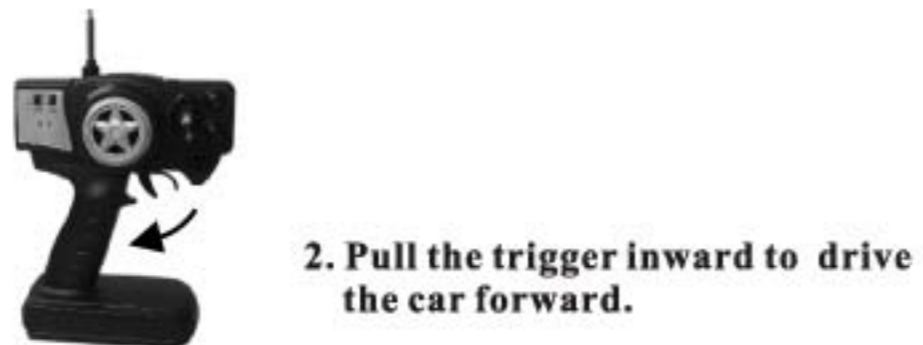

2. Pull the trigger inward to drive the car forward.

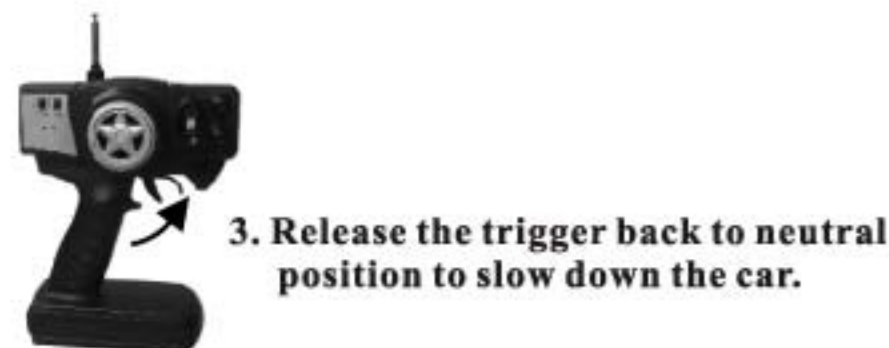

3. Release the trigger back to neutral position to slow down the car.

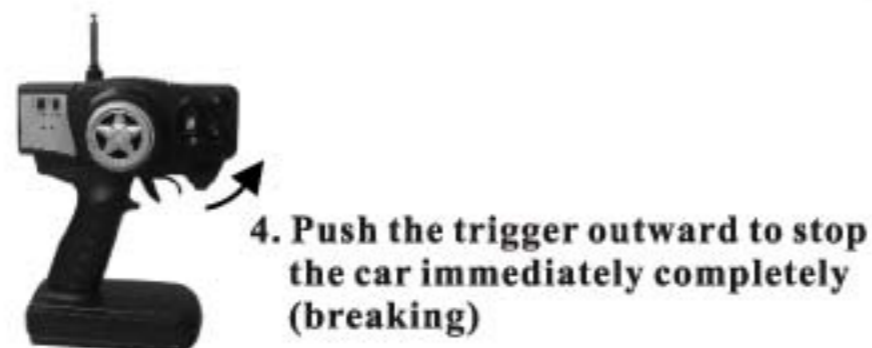

4. Push the trigger outward to stop the car immediately completely (breaking)

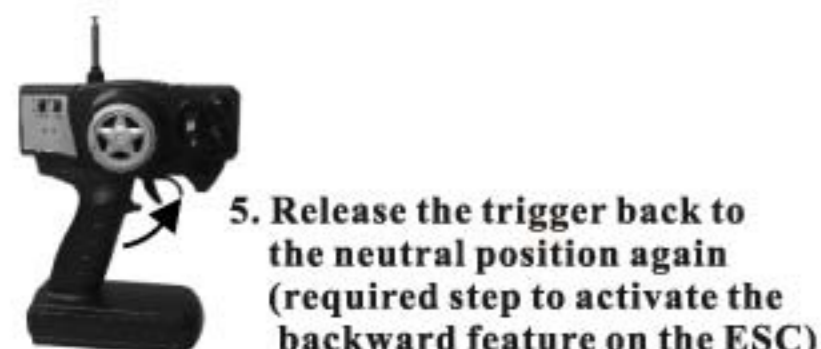

5. Release the trigger back to the neutral position again (required step to activate the backward feature on the ESC)

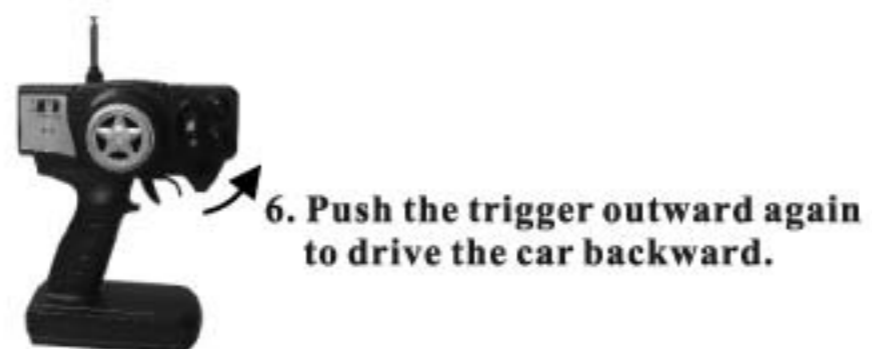

6. Push the trigger outward again to drive the car backward.

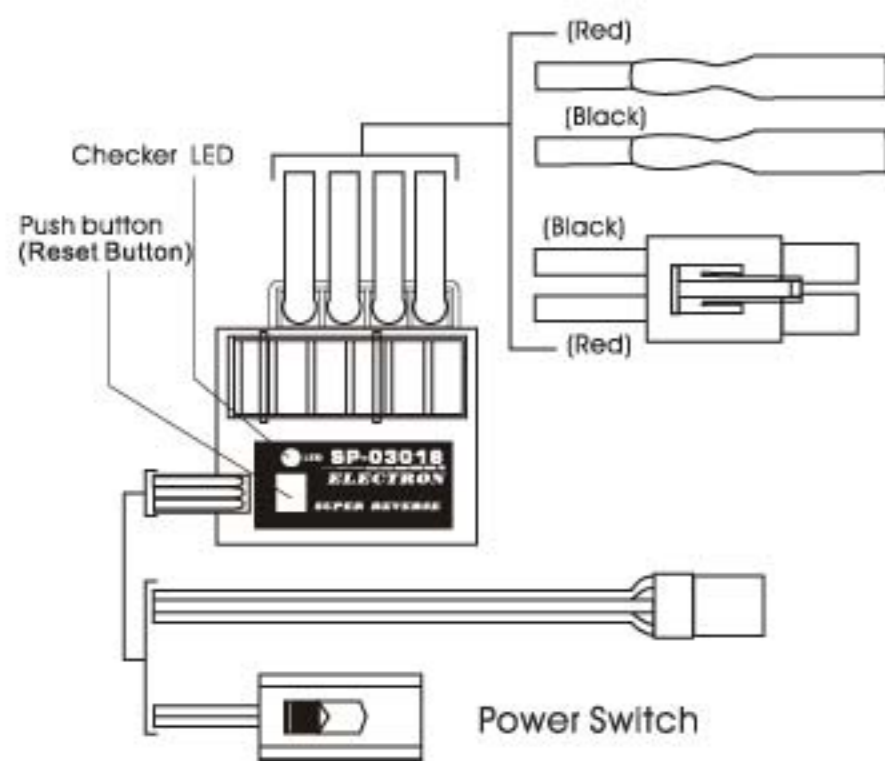



**ESC Reset:**  
If the Sp03018 LED blinks rapidly, this indicates the ESC is in safe mode. Hold the Reset button on the ESC for 8 seconds until the LED blinks slowly, then power off and on the power switch to restart the system.

The ESC will be in safe mode in the following situations:



















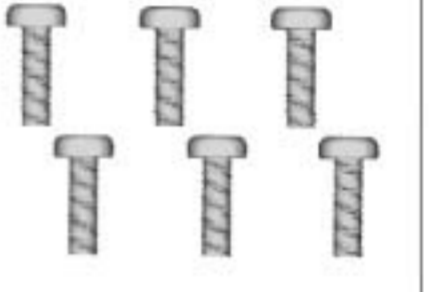

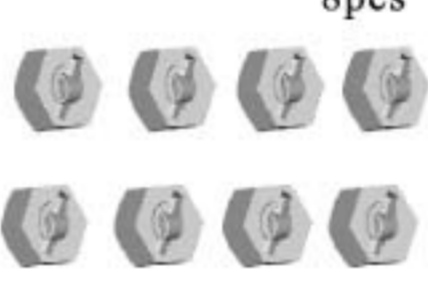

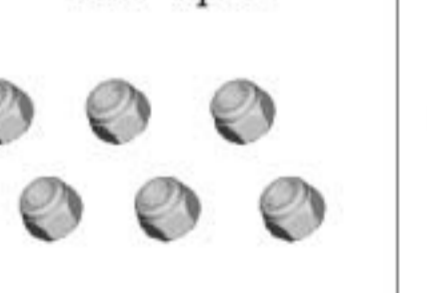
1. Out of the remote control range
2. Extra low/high voltage level from the power system is detected
3. External interference signal is detected.

1. Charge the battery for 8-10 hours for the first time usage. Do not charge the battery unattended.
2. When the car is blocked, do not continue to pull/push the trigger, this will cause the ESC to overheat and damage the ESC.

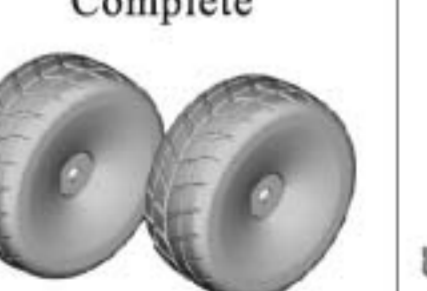
## on-road car(A1)/pro.car(A2)/drift car(E1)/pro.drift car(E2)-spare parts

02002-Shock absorber 2pcs 	02003-Front dog bones Hole track:55mm Total length:61mm 2pcs 	02003T-Rear dog bones Hole track:54.5mm Total length:60mm 2pcs 	02005-Rear bumper 
02007-Rear lower suspension arm 2pcs 	02008-Front lower suspension arm 2pcs 	02009- Front Bumper Upper Cover 	02010- Body post 4pcs 
02012-Front/rear link Servo link 2pcs 	02013- Rear upright+ set screw 2pcs 	02014- Steering hub 2pcs 	02015- Front hub Carrier 2pcs 
02016-Universal joint Cup B 2pcs 	02017- Suspension arm reinforcement brace 2pcs 	02021-Rear arm holder 	02022-Front arm holder 
02025E-Steering set A 	02029- Crown gear 	02030- Drive pinion complete 	02032-Universal joint Cup C 2pcs 
02033-Wheel axle 2pcs 	02035-Front shock tower 	02036-Front suspension arm pin A 2pcs 	02037-E-clip 12pcs (Φ7. Φ4.Φ2.5.Φ2.3) 





02038-Ball head screw 6pcs 	02039-Differential Box +Seals+washers 2pcs 	02042-Rear shock tower 	02051-Gear box 
02052-Front bumper foam 	02053-Body clip 8pcs 	02055-Nylon locknut M4 	02057- Antenna Pipe 4pcs 
02061-Rear lower arm round pin B 2pcs 	02062-Front lower arm round pin B 2pcs 	02063-Rear suspension arm pin A 2pcs 	02064-Rear body post plate 
02066- Diff. Pinions/Pin 	03020-Receiver 	02372-Servo Arm 2P 	Sp3001-Servo(3Kgs) 
02074-Steering ackerman joint 	02075- Steering set B 	02077-Front bumper plate 	02078-O-Ring 12pcs 
02079-Oil bearing ø15*ø10*4- 6pcs 	02080-Oil bearing ø5*ø10*4- 8pcs 	02081- Round head screw 3*8 6P 	02082- Round head self- tapping screw 3*10 10P 

02083- Round head screw 3*12 6P 	02084- Round head screw 3*18 4P 	02085- Round head screw 2*8 8P 	02086- Round head screw 2*10 10P 
02087-Countersunk cross head self-tapping screw 3*10 15P 	02088- Countersunk cross head self-tapping screw 3*14 13P 	02089- Countersunk cross head self-tapping screw 3*15 9P 	02092-ISO 3*10 Screw 8pcs 
02093- Cap head screw M3*10 10P 	02096- Round head screw M3*10 6P 	02098-Grub screw M3*4 8P 	02099-Grub screw M4*4 10P 
02100- Wheel Hex. 8pcs 	02101-Steering bushing 12pcs 	02102-M3 nylon lock nut 6pcs 	02103- Zip tie 
02113-Sealed wheel rim 	02116-Tyre 	02117- Sealed wheel Complete 	03001- Chassis 
03002- Radio tray 	03003-Center dogbone 	03004- Diff.main gear (58T) 	03005-Motor gear(26T) 

on-road car(A1)/pro.car(A2)/drift car(E1)/pro.drift car(E2)-spare parts

03006- Antenna mount 	03007- Motor Mount 	03008- Switch cover 	03009-Battery cover post 
03010-Battery Cover 			
03401-Gear Shelter New 	03011-Motor RC(540) 	03018 Electronic speed controller 	03013-Radio tray mount 
03014-Battery (7.2v 1800mAh) 	03015-Drive gear shaft +E-clips 	02138-Ball Bearing $\phi 15*\phi 10*4$ 6P 	02139-Ball Bearing $\phi 10*\phi 5*4$ 8P 



























pro.on-road car(A2)/pro.drift car(E2)-spare parts

102004-Aluminum Shock Absorber 2P 	107051-Brushless Motor KV:3300  Taiwan	107052T- Brushless Electronic Speed Control Output:75A  Taiwan	02228PL (Gold) 02228PB (Blue) Chrome Plated Spoke Rim With Sprayed 2P 	102048-Aluminum Nut M3 8P 
102049-Aluminum Nut M4 4P 	102068- Wheel Mount Ball Bearings Complete $\phi 10*\phi 5*4$ $\phi 15*\phi 10*4$ 	28446-Brushless Motor KV:5000  Taiwan	03070-Battery Ni-MH (7.2V 2000mAh) 	

on-road drift car(E1)/pro.drift car(E2)-spare parts

02228PL (Gold) 02228PB (Blue) Chrome Plated Spoke Rim With Sprayed 2P 	09001- Tyre 2P 	07003- Drift Wheels Complete 2P  Blue/Gold/Green/Purple Spoke Rim Available		
--	---	--	--	--

on-road car(A1)/pro.car(A2)/drift car(E1)/pro.drift car(E2)-upgradable optionals

102015-Universal Drive Joint 2P 	102004-Aluminum Shock Absorber 2P 	102042-Aluminum Wheel Hex. Mount 4P 	102037-Aluminum Body Post 4P 	102010-Aluminum Front Hub Carrier (L/R) 
102011-Aluminum Steering Hub(L/R) 	102012-Aluminum Rear Hub Carrier (L/R) 	102017-Aluminum Front/rear & Servo Link 2P 	102023-Aluminum Rear Shock Tower 	102019-Aluminum Front Lower Arm 2P 
102021-Aluminum Rear Lower Arm 2P 	102022-Aluminum Front Shock Tower 	102048-Aluminum Nut M3 8P 	102049-Aluminum Nut M4 4P 	107050-Battery pack (7.2V,3000mAh) 
107051-Brushless Motor KV:3300  Taiwan	107052T- Brushless Electronic Speed Control Output:75A  Taiwan	02228PL (Gold) 02228PB (Blue) Chrome Plated Spoke Rim With Sprayed 2P 	102040-Aluminum Ackerman Plate 	103071-Lightweight Motor Mount ★ 
102060-Aluminum Front Gear Box Mount 	102061-Aluminum Rear Gear Box Mount 	102058-Aluminum Front Bumper Upper Plate 	103001T-Carbon Fibre Chassis ★ 	103002T-Carbon Fibre Radio Tray ★ 
103027-Front/Rear Suspension Brace(Al.) ★ 	103022T-Carbon Fibre Front Shock ★ 	103023T-Carbon Fibre Rear Shock ★ 	03320- Fan-for ESC 	28421-Lithium rechargeable battery (11.1V, 2200mAh) ★ 28424-Lithium rechargeable battery (7.4V, 2200mAh) 
28446- Motor RC(550) ★  Taiwan	03028- Fail Safe  Taiwan	28435-Electronic speed controller 20T  Taiwan	28437-Electronic speed controller 15T  Taiwan	28430-Lithium battery Charger  Taiwan

The actual received parts may vary from the images!  
Optional parts are subject to change without prior notice.

The images with ★ are still undeveloped and will come in near future.



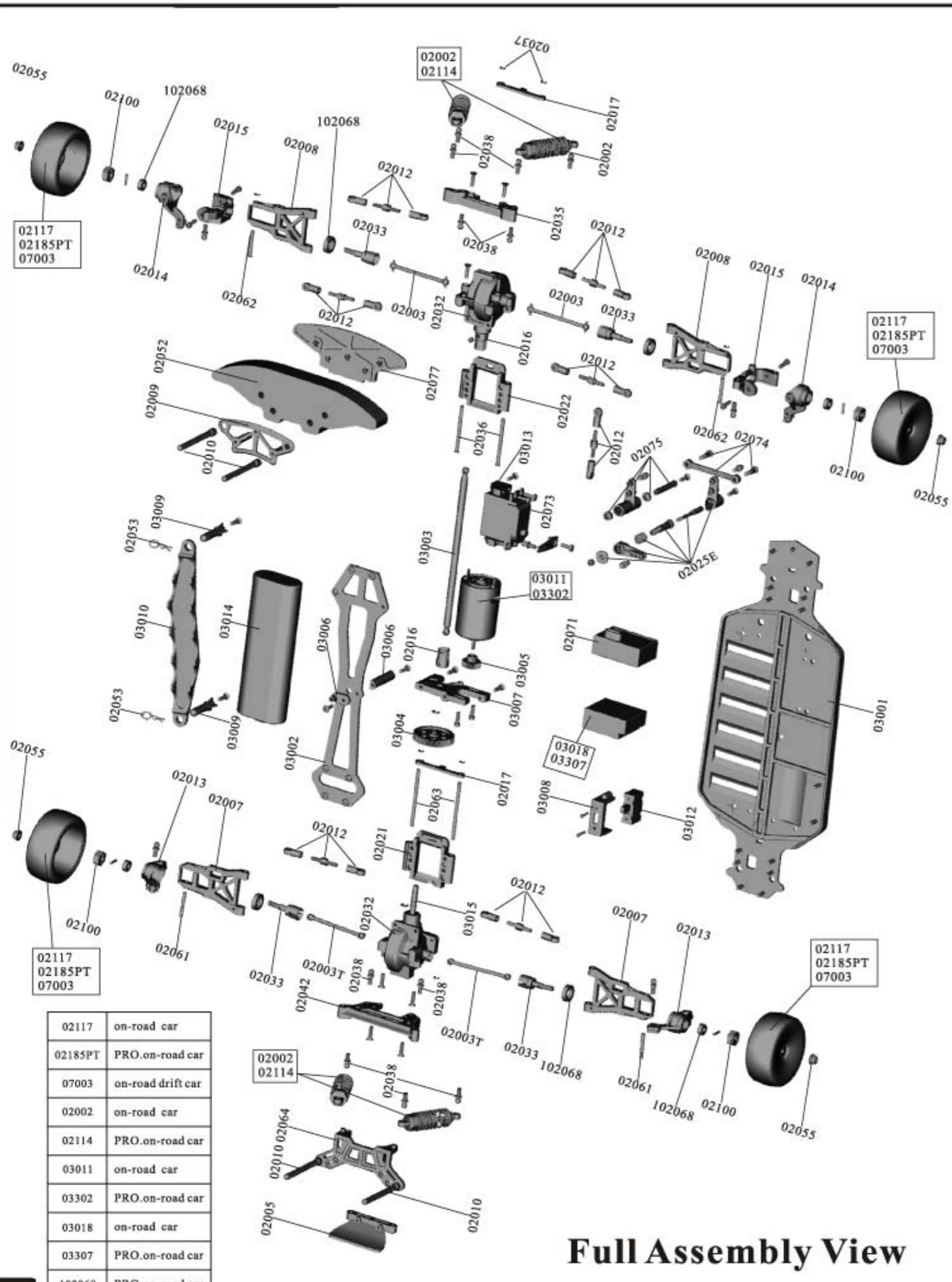









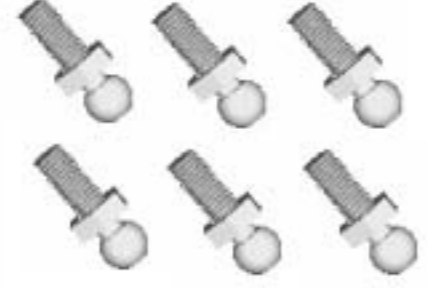











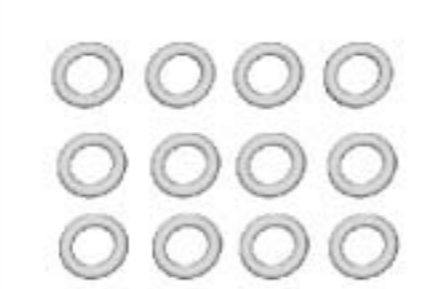

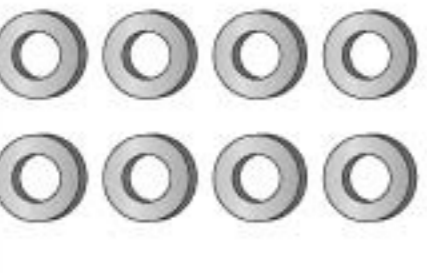

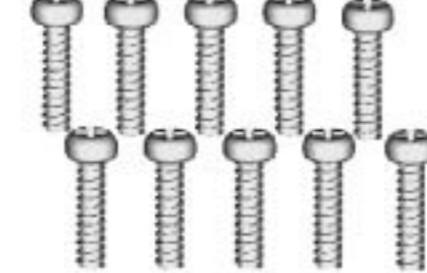
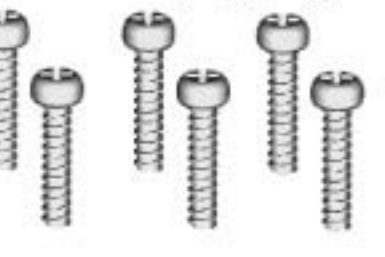

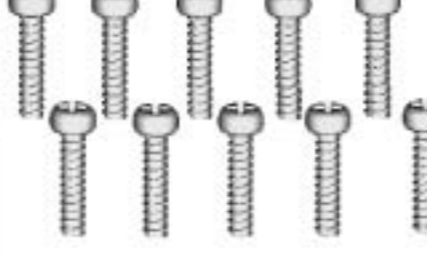

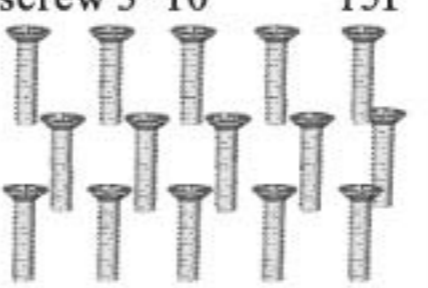



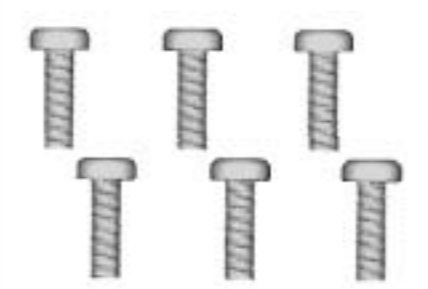







**Full Assembly View**



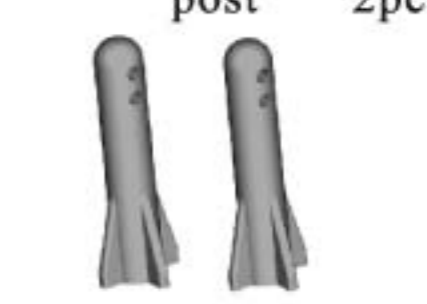

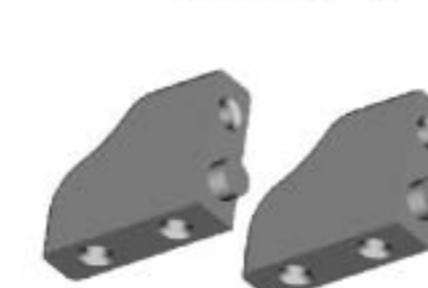
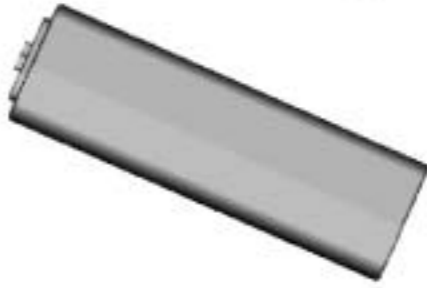
02117	on-road car
02185PT	PRO.on-road car
07003	on-road drift car
02002	on-road car
02114	PRO.on-road car
03011	on-road car
03302	PRO.on-road car
03018	on-road car
03307	PRO.on-road car
102068	PRO.on-road car

06002-Shock Absorber 	06004-Front Body Mount 	06007-Link Ball Head 4P 	06011-Front Lower Suspension Arm 
06012-Rear Lower Suspension Arm 	06013-Front Shook Tower 	06014-Rear Shook Tower 	06016-Front/rear link/Servo Link 2P 
06018-Front Lower Arm Pin B 2P 	06019-Rear Lower Arm Round Pin B 2pcs 	06020-Wing Mount 2P 	06023-Shock Ball Stud 4P 
06024-Wheel Rim (Rear) 2P 	02013-Rear upright + set screws 2P 	02014-Steering hub 2P 	02015-Front hub carrier 2P 
02016-Universal Joint Cup B 2P 	02017-Suspension reinforcement brace 2P 	02021-Rear Suspension Arm Holder 	02022-Front Suspension Arm Holder 
02024-Diff.Main Gear Complete 	02025E-Steering Assembly A 	02032-Universal Joint Cup C 2P 	02033-Steering Axle 2P 

02036-Front suspension arm pin A 2P 	02037-E-Clip 12 Pcs (φ7. φ4. φ2.5. φ2.3) 	02038-Ball Head Screw 6pcs 	02039- Diff. Box+seals +washers 2P 
02051- Gear Box 	02053-Body clip 8P 	02055-M4 Nylon Nut 8P 	02057-Antenna Pipe 4P 
02063-Rear Lower Arm Round Pin A 2P 	02066-Diff.pinions+ pin 	03020-Receiver 	02372-Servo arm 2P 
Sp3001-Servo(3Kgs) 	02074-Steering ackerman joint 	02075-Steering Assembly B 	02078-O-Ring 12 P 
02079-Oil Bearing φ15*φ10*4 6P 	02080-Oil Bearing φ5*φ10*4 8P 	02081-Round head screw 3*8 6P 	02082-Round head screw 3*10 10P 
02083-Round head self-tapping screw 3*12 6P 	02084-Round head screw 3*18 4P 	02085-Round head screw 2*8 8P 	02086-Round head screw 2*10 10P 

02087-Countersunk cross head self-tapping screw 3*10 15P 	02088-Countersunk cross head self-tapping screw 3*14 13P 	02089-Countersunk cross head self-tapping screw 3*15 9P 	02092-ISO 3*10 Screw 8Pcs 
02093- Cap head screw M3*10 10P 	02096-M3*10 Cap head screw 6P 	02098-M3*3 Grub Hex. Screw 8P 	02099-M4*4 Grub Hex. Screw 10P 
02101-Steering bushing 12P 	02102-M3 Nylon nut 6P 	02103-Zip tie 6P 	02138- Ball bearing φ15*φ10*4 6P 
02139- Ball bearing φ10*φ5*4 8P 	11164- Diff. Main gear (64T) 	11153- Motor gear (23T) 	03006- Antenna mount 
03007- Motor mount 	03008- Switch cover 	03009- Battery cover post 2pcs 	03010- Battery cover 
03011- MotoRC(540) 	03013- Radio tray Holder A 	03014- Battery Pack (7.2V 1800mA) 	03015- Drive Gear Pin +E-Clip 

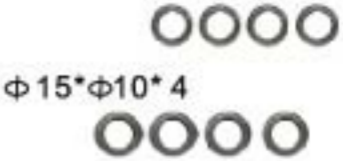

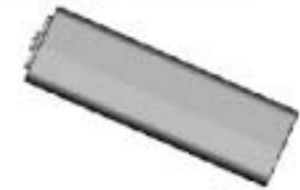

03018- Electronic Speed Controller 	04001- Chassis 	04002- Radio tray 	04003- Centre drive joint 	04004- Battery Holder 
03300-Motor Heat proof Cover 	03401-Gear Shelter New 			

102048-Aluminum Nut M3 8P 	102049-Aluminum Nut M4 4P 	102068- Wheel Mount Ball Bearings Complete KV:5000 $\phi 10^* \phi 5^* 4$ $\phi 15^* \phi 10^* 4$ 	28446-Brushless Motor KV:5000 Taiwan 	03070-Battery Ni-MH (7.2V 2000mAh) 
--	--	---	---	---















off-road buggy(B1)/pro.off-road buggy(B2)-spare parts

06003-Front Bumper 	06005-Wing Post 	06017-Wing Brace 2P 	06022-Front/rear dogbone 100mm*4 2P 	02005-Rear Bumper 
06008-Wheel Rim (front) 2P 	06009-Tyre(Front) 2P 	06010-Front Wheel Complete 2P 	06021-Wing 	02100-Wheel Hex. 8P 
06025-Tyre(Rear) 2P 	06026-Rear Wheel Complete 2P 			

pro.off-road buggy(B2)/pro.rally monster(H2)-spare parts

106004-Aluminum Shock Absorber 2P 	107051-Brushless Motor KV:3300 Taiwan 	107052T- Brushless Electronic Speed Control Output:75A Taiwan 	06008PL(Gold) 06008PB(Blue) Front Chrome Plated Spoke Rim 2P 	06024PL(Gold) 06024PB(Blue) Rear Chrome Plated Spoke Rim 2P 
--	---	---	--	--

rally monster(H1)/pro.rally monster(H2)spare parts

17021-Front Bumper Set  (6*10)	15504-Rear Bumper Set 	62013-Body Post 4P 	62017-Body Post Mount(F) 2P 	62018-Body Post Mount(R) 2P 
08059-Dogbone(F/R) 89.5mm 2P 	15506-Wheel Axle 2P 	08065-Wheel Hex. 4P 	15505-RearAnti-Squat Plate 	06024-Wheel Rims (F/R) 2P 
15501-Tires(F/R) 2P 	15502-Wheel Complete (F/R) 2P 	62051-Ball Head Self-tapping screw (2.6*12) 4P 	06102-Wheel Rims(F/R) 2P 	

102010-Aluminum Front Hub Carrier (L/R) 	102011-Aluminum Steering Hub(L/R) 	102012-Aluminum Rear Hub Carrier (L/R) 	102042-Aluminum Wheel Hex. Mount 4P 
102048-Aluminum Nut M3 8P 	102049-Aluminum Nut M4 4P 	106017-Aluminum Front/rear & Servo Link 2P 	106019-Aluminum Front Lower Arm 2P 
106021-Aluminum Rear Lower Arm 2P 	106022-Aluminum Front Shock Tower 	106023-Aluminum Rear Shock Tower 	107050-Battery pack (7.2V,3000mAh) 
102040-Aluminum Ackerman Plate 	102060-Aluminum Front Gear Box Mount 	106044-Aluminum Wing Stay(L/R)+Posts for off-road buggy/pro.buggy 	106045-Aluminum Wing Adjustable Mount for off-road buggy/pro.buggy 
102061-Aluminum Rear Gear Box Mount 	111001T-Carbon Fibre Chassis ★ 	111002T-Carbon Fibre Radio Tray ★ 	103027-Front/Rear Suspension Brace(Al.)★ 
103071-Lightweight Motor Mount ★ 	107022T-Carbon Fibre Front Shock ★ 	107023T-Carbon Fibre Rear Shock ★ 	28424-Lithium rechargeable battery (7.4V, 2200mAh) ★ 

03320- Fan-for ESC 	107051-Brushless Motor KV3300 Taiwan 	107052T-Brushless ESC 75A Taiwan 	106015-Front CVD Set 2P 
102068- Wheel Mount Ball Bearings Complete φ10*φ5*4 φ15*φ10*4 	106004-Full Aluminum Shock Sets 2P 	06008PL(Gold) 06008PB(Blue) Front Chrome Plated Spoke Rim 2P 	06024PL(Gold) 06024PB(Blue) Rear Chrome Plated Spoke Rim 2P 
111001T- Carbon Fibre Chassis 	111002T- Carbon Fibre Radio Tray 	28446- Motor RC(550) ★ Taiwan 	03028- Fail Safe Taiwan 
28435-Electronic speed controller 20T Taiwan 	28437-Electronic speed controller 15T Taiwan 	28430-Lithium battery Charger Taiwan 	28453-2CH CHARGER Taiwan 
28454-3Power Switch 	28456-3CH CHARGER 		

The actual received parts may vary from the images!





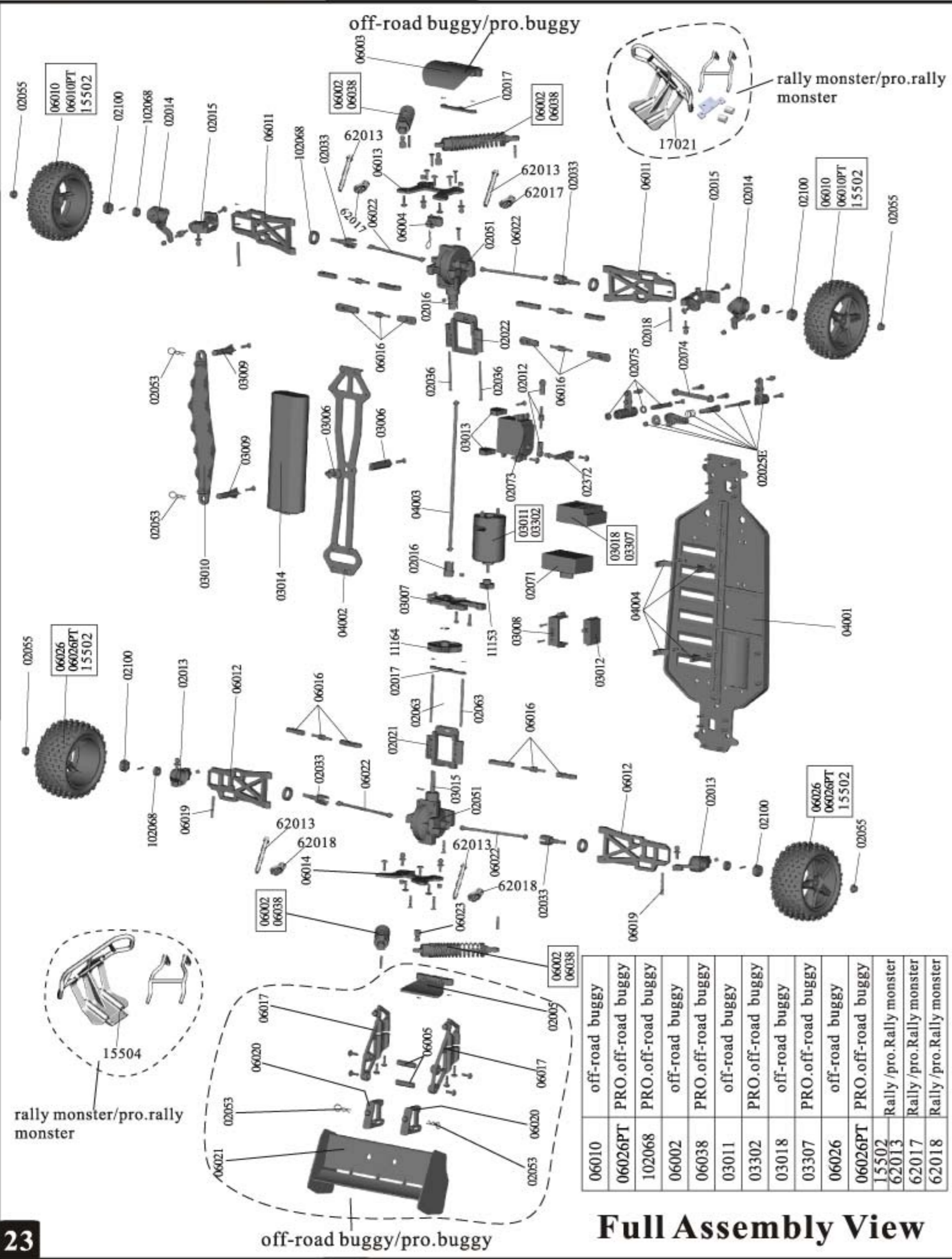













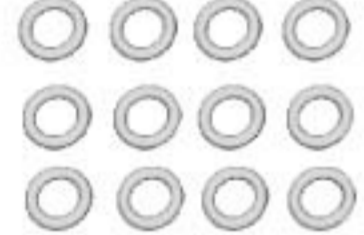



Optional parts are subject to change without prior notice.



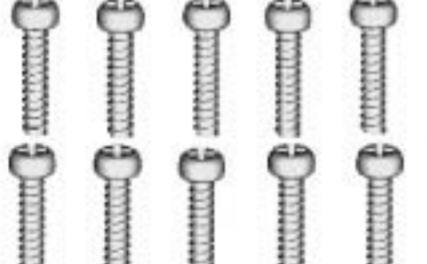
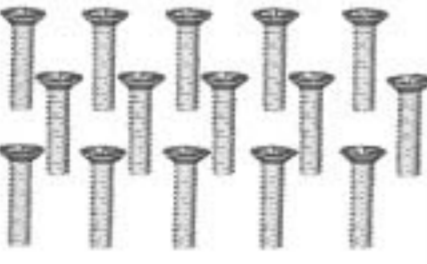















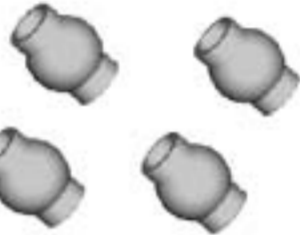

The images with ★ are still undeveloped and will come in near future.



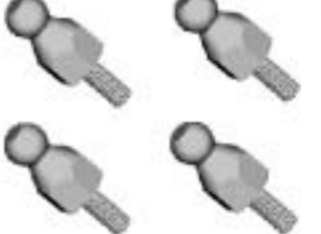
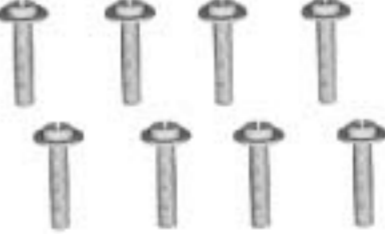
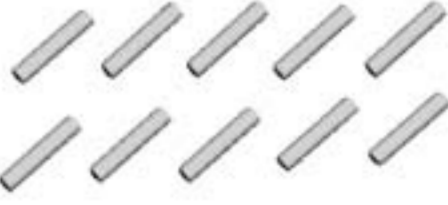













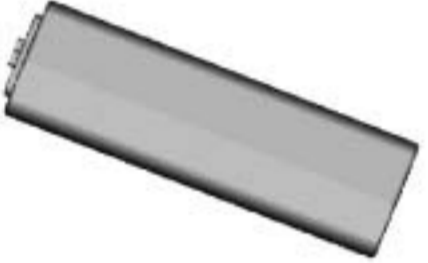

06010	off-road buggy
06026PT	PRO.off-road buggy
102068	PRO.off-road buggy
06002	off-road buggy
06038	PRO.off-road buggy
03011	off-road buggy
03302	PRO.off-road buggy
03018	off-road buggy
03307	PRO.off-road buggy
06026	off-road buggy
06026PT	PRO.off-road buggy
15502	Rally /pro.Rally monster
62013	Rally /pro.Rally monster
62017	Rally /pro.Rally monster
62018	Rally /pro.Rally monster

08001-Shock Absorber	08008N-Wheel Rim 2P	08009N-Tyre 2P	08010N-Wheel Complete 2P
08003-Rear bumper	06016-Servo link 2P	02013-Rear upright +set screws 2P	02014-Steering hubs 2P
02015-Front hub carrier 2P	02016-Universal Joint Cup B 2P	02017- Suspension reinforcement brace 2P	02021- Rear suspension arm Holder
02022- Front suspension arm Holder	02024-Diff.gear complete	08425E-Steering Assembly A	02029-Diff.main gear
02032-Universal Joint Cup C 2P	02033-Wheel Axle 2P	02036-Front Lower Arm Pin A 2P	02037-E-Clip 12 pcs (Φ7. Φ4.Φ2.5.Φ2.3)
02038-Ball Head Screw 6pcs	02039-Diff. Box (with 2 Rings &Steel washers)	02051-Gear Box	02053-Body clip 8P

02055- M4 nylon nut 8P 	02057-Antenna Pipe 4P 	02063-Rear Lower 2P Arm Pin A 	02066-Diff.pinions+ pin 
03020-Receiver 	02372-Servo arm 2P 	Sp3001-Servo(3Kgs) 	02074-Steering Joint 
02075-Steering Assembly B 	02078- Seals 12P 	02079-Oil bearing $\phi 15 * \phi 10 * 4$ - 6pcs 	02080-Oil bearing $\phi 5 * \phi 10 * 4$ - 8pcs 
02081- Round head screw $3 * 8$ 6P 	02082- Round head self- tapping screw $3 * 10$ 10P 	02083- Round head screw $3 * 12$ 6P 	02084- Round head screw $3 * 18$ 4P 
02085- Round head screw $2 * 8$ 8P 	02086- Round head screw $2 * 10$ 10P 	02087- Countersunk cross head self-tapping screw $3 * 10$ 15P 	02088- Countersunk cross head self-tapping screw $3 * 14$ 13P 
02089- Countersunk cross head self-tapping screw $3 * 15$ 9P 	02092-ISO screw $3 * 10$ 8P 	02093- Cap head screw $M3 * 10$ 10P 	02096- Round head screw $M3 * 10$ 6P 

02098-Grub screw $M3 * 4$ 8P 	02099-Grub screw $M4 * 4$ 8P 	02100- Wheel Hex. 8P 	02101-Steering Bushing 12P 
02102- M3 nylon lock nut 6P 	02103- Zip Tie 6P 	02138- Rolling Bearing $\phi 15 * \phi 10 * 4$ - 6pcs 	02139- Rolling Bearing $\phi 10 * \phi 5 * 4$ - 8pcs 
08002-Front bumper 	06007-Shock Ball Head 4P 	08005- Front Lower Suspension Arm 2P 	08006- Rear Lower Suspension Arm 2pcs 
08007-Body post 4P 	08012-Shock Tower 	08019-Rear Lower Arm Pin B 2pcs 	08020-Front Lower Arm Pin B 2pcs 
08021-Shock Ball Head Holder 4P 	08024- Discal screw $M3 * 10$ 8P 	08027-Pin $2 * 10$ 10P 	08029-Front/rear dogbone 88 mm 2P 
08028-Bump Post 4P 	08032-Bumper spring 4P 	08042- Front/rear link 2P 	03006- Antenna Mount 





















off-road truck(C1)/pro.off-road truck(C2)-spare parts

03007- Motor Mount 	03008- Switch Cover 	03009- Battery cover post 	03010- Battery cover 
03011- MotorRC(540) 	03013- Radio tray holder 	03015- Drive shaft+E-clip 	03018- Electronic Speed Controller 
03014-Battery Pack (7.2V 1800mA) 	04001- Chassis 	04002- Radio tray 	04003- Centre dogbone 
04004- Battery Corner Holder 	11164- Diff. Main Gear (64T) 	11119- Motor Gear (17T) 	03300-Motor Heat proof Cover 
08003-Rear bumper 	12101-jeep Body (clarity) 	11601-army Body (clarity) 	11701-wecker Body (clarity) 
08150-Tire Insert Sponge 2P 	03401-Gear Shelter New 		

pro.off-road truck(C2)-spare parts

108004-Aluminum Shock Absorber 2P 	107051-Brushless Motor KV:3300  Taiwan	107052T- Brushless Electronic Speed Control 75A  Taiwan	08008NPL (Gold) 08008NPB (Blue) Chrome Plated Spoke Rim With Sprayed 2P 	102068- Wheel Mount Ball Bearings Complete φ 10*φ 5* 4 φ 15*φ 10* 4 
102048-Aluminum Nut M3 8P 	102049-Aluminum Nut M4 4P 	28446-Brushless Motor KV:5000 	03070-Battery Ni-MH (7.2V 2000mAh) 	

off-road truck(C1)/pro.off-road truck(C2)-upgradable optionals

102010-Aluminum Front Hub Carrier (L/R) 	102011-Aluminum Steering Hub(L/R) 	102012-Aluminum Rear Hub Carrier (L/R) 	102042-Aluminum Wheel Hex. Mount 4P 	102048-Aluminum Nut M3 8P 
102049-Aluminum Nut M4 4P 	106017-Aluminum Front/rear & Servo Link 2P 	108015-Universal Drive Joint 2P 	108019-Aluminum Front Lower Arm 2P 	108021-Aluminum Rear Lower Arm 2P 
108022-Aluminum Shock Tower 	108037-Aluminum Body Post 4P 	108004-Aluminum Shock Absorber 2P 	107050-Battery pack (7.2V,3000mAh) 	107051-Brushless Motor KV:3300  Taiwan
107052T-Brushless Electronic Speed Control 75A  Taiwan	08008NPL (Gold) 08008NPB (Blue) Chrome Plated Spoke Rim With Sprayed 2P 	102040-Aluminum Ackerman Plate 	102060-Aluminum Front Gear Box Mount 	102061-Aluminum Rear Gear Box Mount 

off-road truck(C1)/pro.off-road truck(C2)-upgradable optionals

111022T-Carbon Fibre Front Shock ★ 	111023T-Carbon Fibre Rear Shock ★ 	28421-Lithium rechargeable battery (11.1V, 2200mAh) ★ 	28424-Lithium rechargeable battery (7.4V, 2200mAh) ★ 	103027-Front/Rear Suspension Brace(Al.) ★ 
103071-Lightweight Motor Mount ★ 	102068- Wheel Mount Ball Bearings Complete φ10*φ5*4 φ15*φ10*4 	111001T- Carbon Fibre Chassis ★ 	111002T- Carbon Fibre Radio Tray ★ 	03320- Fan-for ESC 
28446- Motor RC(550) ★ 	03028- Fail Safe 	28435-Electronic speed controller 20T Taiwan 	28437-Electronic speed controller 15T Taiwan 	28430-Lithium battery Charger 
28453-2CH CHARGER Taiwan 	28454-3Power Switch 	28456-3CH CHARGER 		

08010N	off-roadmonster/wecker/army/jeep
08010NPT	PRO.off-road truck
08001	off-roadmonster/wecker/army/jeep
08041	PRO.off-road truck
03011	off-roadmonster/wecker/army/jeep
03302	PRO.off-road truck
03018	off-roadmonster/wecker/army/jeep
03307	PRO.off-road truck

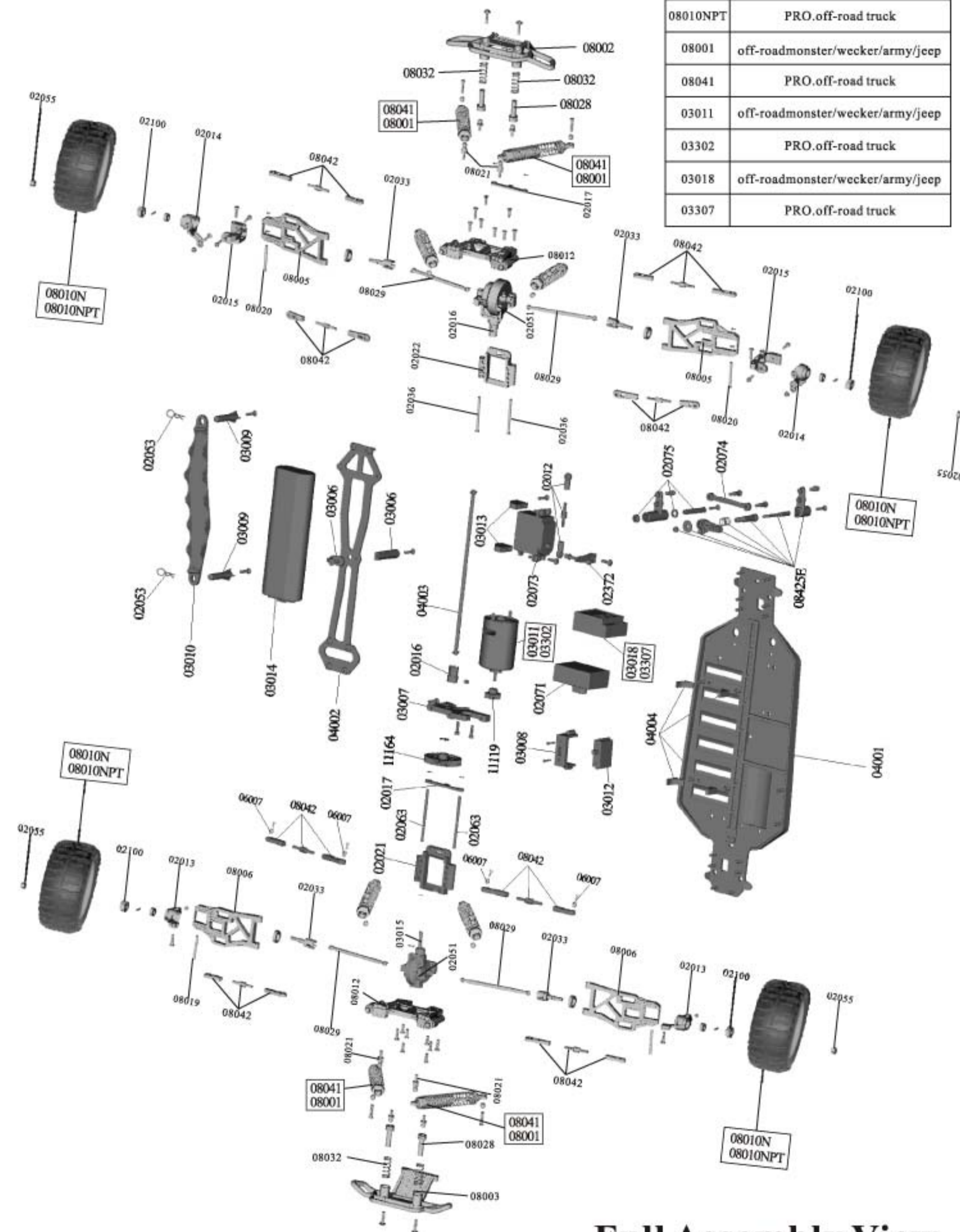





















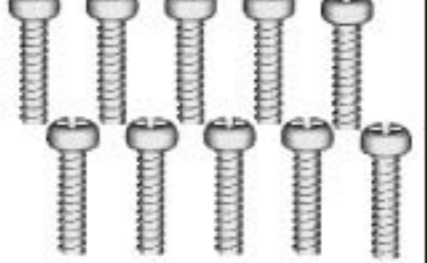

The actual received parts may vary from the images!  
Optional parts are subject to change without prior notice.









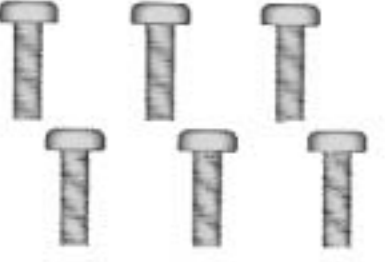









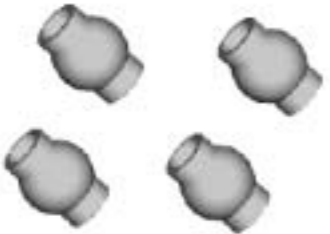



The images with ★ are still undeveloped and will come in near future.

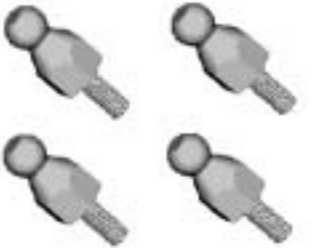

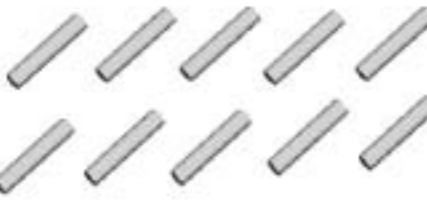







Full Assembly View























17701-Truggy Wheel Rim 2P 	17702-Pre-mounted Truggy Tyre 2P 	17703-Truggy Wheel Complete 2P 	17704-Truggy Shock Absorber 2P for off-road truggy(1)(D1) only 
02005-Rear Bumper 	06016-Servo link 2P 	02013-Rear upright +set screws 2P 	02014-Steering hubs 2P 
02015-Front hub carrier 2P 	02016-Universal Joint Cup B 2P 	02017- Suspension reinforcement brace 2P 	02021- Rear suspension arm Holder 
02022- Front suspension arm Holder 	02024-Diff.gear complete 	08425E-Steering Assembly A 	02029-Diff.main gear 
02032-Universal Joint Cup C 	02033N-Steering Axle 	02036-Front Lower Arm Pin A 2P 	02037-E-Clip 12 pcs (Ø7. Ø4.Ø2.5.Ø2.3) 
02038-Ball Head Screw 6pcs 	02039-Diff. Box (with 2 Rings & Steel washers) 	02051-Gear Box 	02053- Body clip 8P 









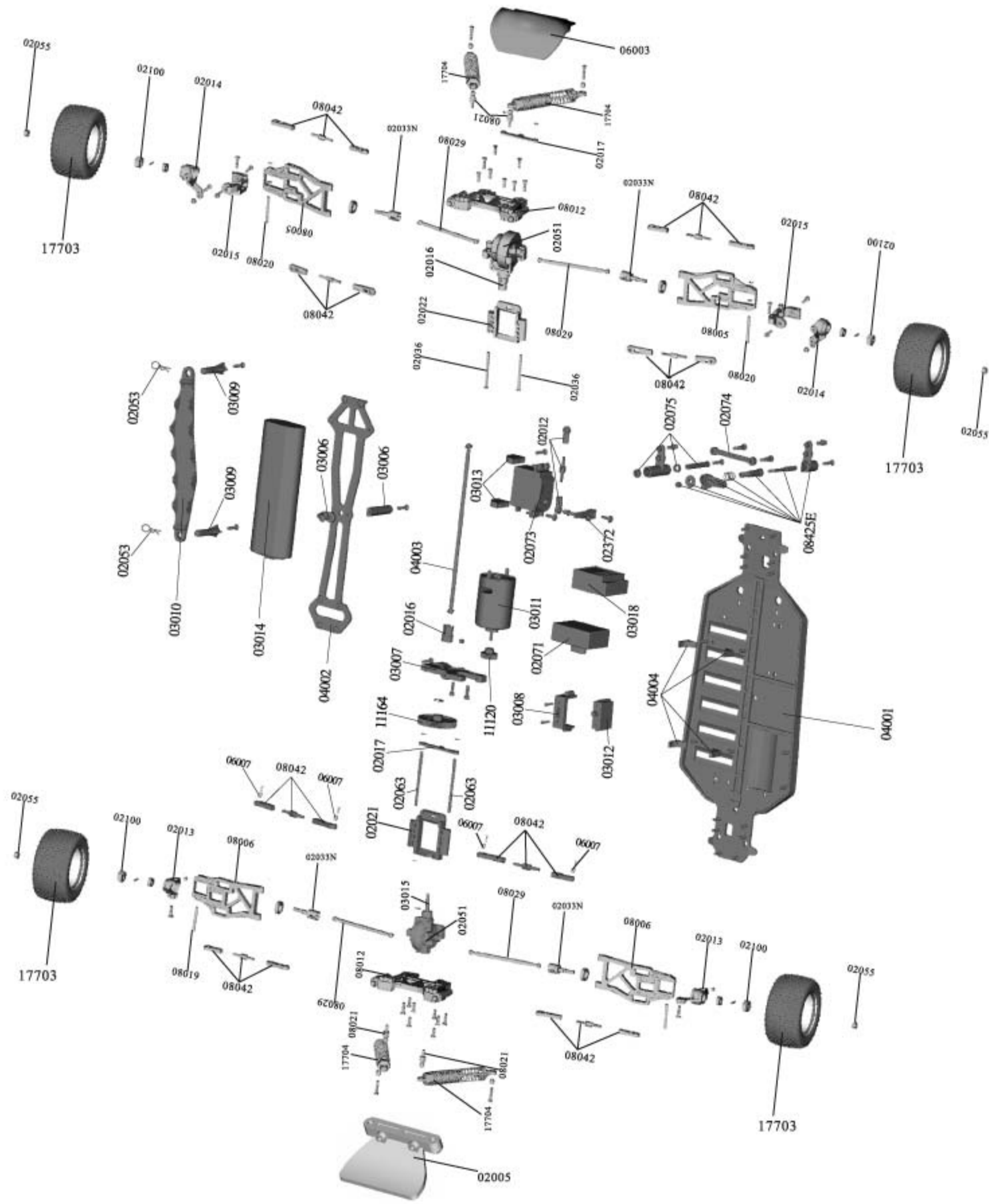





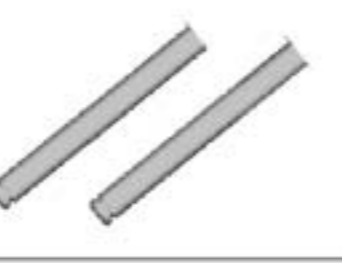









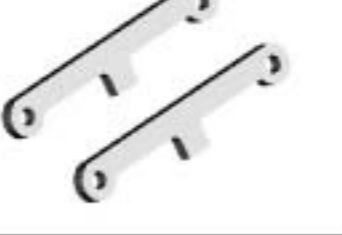







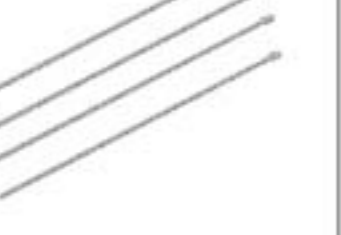

02055- M4 nylon nut 8P 	02057-Antenna Pipe 4P 	02063-Rear Lower Arm Pin A 2P 	02066- Diff.pinions+ pin 
03020-Receiver 	02372-Servo arm 2P 	Sp3001-Servo(3Kgs) 	02074-Steering Joint 
02075-Steering Assembly B 	02078- Seals 12P 	02079-Oil bearing Ø15*Ø10*4- 6pcs 	02080-Oil bearing Ø5*Ø10*4- 8pcs 
02081-Round head screw 3*8 6P 	02082-Round head Self-tapping screw 3*10 10P 	02083-Round head screw 3*12 6P 	02084-Round head screw 3*18 4P 
02085-Round head screw 2*8 8P 	02086-Round head screw 2*10 10P 	02087-Countersunk cross head self-tapping screw 3*10 15P 	02088-Countersunk cross head self-tapping screw 3*14 13P 
02089-Countersunk cross head self-tapping screw 3*15 9P 	02092-ISO screw 3*10 8P 	02093-Cap head screw M3*10 10P 	02096-Round head screw M3*10 10P 

02098-Grub screw M3*4 8P 	02099-Grub screw M4*4 10P 	02100-Wheel Hex. 8P 	02101-Steering bushing 12p 
02102- M3 nylon locknut 6P 	02103- Zip Tie 6P 	02138-Rolling Bearing φ15* φ10*4 - 6pcs 	02139- Rolling Bearing φ10* φ5*4 - 8pcs 
06003-Front Bumper 	06007-Link ball head 4P 2P 	08005-Front Lower Suspension Arm 2P 	08006- Rear Lower Suspension Arm 2P 
08007-Body post 4P 	08012-Shock Tower 	08019-Rear Lower Arm Pin B 2pcs 	08020-Front Lower Arm Pin B 2pcs 
08021-Shock Ball Head Holde r 	08024-Discal screw M3*10* 8 	08027-Pin 2*10 10P 	08029-Front/rear dogbone 88 mm 2P 
08042- Front/rear link 2P 	03006- Antenna Mount 	03007- Motor Mount 	03008- Switch Cover 





03009- Battery cover post 	03010- Battery cover 	03011- Motor RC(540) for off-road truggy(1)(D1) only 	03013- Radio tray holder 
03015- Drive shaft+ E-clip 	03018- Electronic Speed Controller for off-road truggy(1)(D1) only 	03014-Battery Pack (7.2V 1800mA) for off-road truggy(1)(D1) only 	04001- Chassis 
04002- Radio tray 	04003- Centre dogbone 	04004- Battery Corner Holder 	11164- Diff. Main Gear (64T) 
11120- Motor Gear (18T) 	03300-Motor Heatproof Cover 	08151-Tire Insert Sponge 2P 	03401-Gear Shelter New 

<p>102010-Aluminum Front Hub Carrier (L/R)</p> 	<p>102011-Aluminum Steering Hub(L/R)</p> 	<p>102012-Aluminum Rear Hub Carrier (L/R)</p> 	<p>102042-Aluminum Wheel Hex. Mount 4P</p> 
<p>102048-Aluminum Nut M3 8P</p> 	<p>102049-Aluminum Nut M4 4P</p> 	<p>106017-Aluminum Front/rear &amp; Servo Link 2P</p> 	<p>108015-Universal Drive Joint 2P</p> 
<p>108019-Aluminum Front Lower Arm 2P</p> 	<p>108021-Aluminum Rear Lower Arm 2P</p> 	<p>108022-Aluminum Shock Tower</p> 	<p>108037-Aluminum Body Post 4P</p> 
<p>110004-Aluminum Shock Absorber 2P</p> 	<p>107050-Battery pack (7.2V,3000mAh)</p> 	<p>107051-Brushless Motor KV:3300</p>  <p>Taiwan</p>	<p>107052T-Brushless Electronic Speed Control Output:75A</p>  <p>Taiwan</p>
<p>28446- Motor RC(550) ★</p>  <p>Taiwan</p>	<p>03028- Fail Safe</p>  <p>Taiwan</p>	<p>28435-Electronic speed controller 20T</p>  <p>Taiwan</p>	<p>28437-Electronic speed controller 15T</p>  <p>Taiwan</p>
<p>28430-Lithium battery Charger</p>  <p>Taiwan</p>	<p>28453-2CH CHARGER</p>  <p>Taiwan</p>	<p>28454-3Power Switch</p> 	<p>28456-3CH CHARGER</p> 



06002-Shock Absorber for off-road truggy(2)(F1) only 	06003-Front Bumper 	06005-Wing Post 	06017-Wing Brace 2P 	06018-Front Lower Arm Pin B 2P 
06019-Rear Lower Arm Round Pin B 2pcs 	06020-Wing Mount 2P 	06021-Wing 	06023-Shock Ball Stud 4P 	02005-Rear Bumper 
02013-Rear upright + set screws 2P 	02014-Steering hub 2P 	02015-Front hub carrier 2P 	02016-Universal Joint Cup B 2P 	02017-Suspension reinforcement brace 2P 
02021-Rear Suspension Arm Holder 	02022-Front Suspension Arm Holder 	02024-Diff.Main Gear Complete 	02025E-Steering Assembly A 	02032-Universal Joint Cup C 2P 
02033-Steering Axle 2P 	02036-Front suspension arm pin A 2P 	02037-E-Clip 12 Pcs (Φ7. Φ4. Φ2.5. Φ2.3) 	02039- Diff. Box+seals +washers 2P 	02051- Gear Box 
02053-Body clip 8P 	02057-Antenna Pipe 4P 	02063-Rear Lower Arm Round Pin A 2P 	02066-Diff.pinions+ pin 	03020-Receiver 
02372-Servo arm 2P 	Sp3001-Servo(3Kgs) 	02074-Steering ackerman joint 	02075-Steering Assembly B 	02079-Oil Bearing Φ15*Φ10*4 6P 

02080-Oil Bearing Φ5*Φ10*4 8P 	02081-Round head screw 3*8 6P 	02082-Round head screw 3*10 10P 	02083-Round head self-tapping screw 3*12 6P 	02086-Round head screw 2*10 10P 
02087-Countersunk cross head self-tapping screw 3*10 15P 	02088-Countersunk cross head self-tapping screw 3*14 13P 	02089-Countersunk cross head self-tapping screw 3*15 9P 	02092-ISO 3*10 Screw 8Pcs 	02093- Cap head hex screw M3*10 10P 
02096-M3*10 Cap head screw 6P 	02138- Ball bearing Φ15*Φ10*4 6P 	02139- Ball bearing Φ10*Φ5*4 8P 	11164- Diff. Main gear (64T) 	11153- Motor gear (23T) 
03006- Antenna mount 	03007- Motor mount 	03008- Switch cover 	03009- Battery cover post 2pcs 	03401-Gear Shelter New 
03010- Battery cover 	03011- Motor RC(540) for off-road truggy(2)(F1) only 	03013- Radio tray Holder A 	03014- Battery Pack (7.2V 1800mA) for off-road truggy(2)(F1) only 	03015- Drive Gear Pin +E-Clip 
03018- Electronic Speed Controller for off-road truggy(2)(F1) only 	04001- Chassis 	04002- Radio tray 	04003- Centre drive joint 	04004- Battery Holder 
03300-Motor Heat proof Cover 	03020-Receiver 	04003- Centre drive joint 	04004- Battery Holder 	03300-Motor Heat proof Cover 
17701-Truggy Wheel Rim 2P 	17702-Pre-mounted Truggy Tyre 2P 	17703-Truggy Wheel Complete 2P 	12001-Front Lower Arm 2P 	12002-Rear Lower Arm 2P 

12003-Front Shock Tower 	12004-Rear Shock Tower 	12005-Front/rear link 4P 	12006-Steering Link 2P 	12007-Front/rear dogbone 100mm*4 2P 
--	---	---	--	--

off-road truggy(2)(F1)/pro.off-road truggy(2)(F2))  
-upgradable optionals

102010-Aluminum Front Hub Carrier (L/R) 	102011-Aluminum Steering Hub(L/R) 	102012-Aluminum Rear Hub Carrier (L/R) 	102042-Aluminum Wheel Hex. Mount 4P 	102048-Aluminum Nut M3 8P 
102049-Aluminum Nut M4 4P 	106004-Aluminum Shock Absorber 2P 	106015-Universal Drive Joint 2P 	106017-Aluminum Front/rear & Servo Link 2P 	120101-Aluminum Front Lower Arm 2P 
120102-Aluminum Rear Lower Arm 2P 	120103-Aluminum Front Shock Tower 	120104-Aluminum Rear Shock Tower 	107050-Battery pack (7.2V,3000mAh) 	107051-Brushless Motor KV:3300  Taiwan
107052T-Brushless Electronic Speed Control 75A  Taiwan	03320- Fan-for ESC 	28446- Motor RC(550)  Taiwan	03028- Fail Safe  Taiwan	28435-Electronic speed controller 20T  Taiwan
28437-Electronic speed controller 15T  Taiwan	28430-Lithium battery Charger  Taiwan	28453-2CH CHARGER  Taiwan	28454-3Power Switch  Taiwan	28456-3CH CHARGER  Taiwan

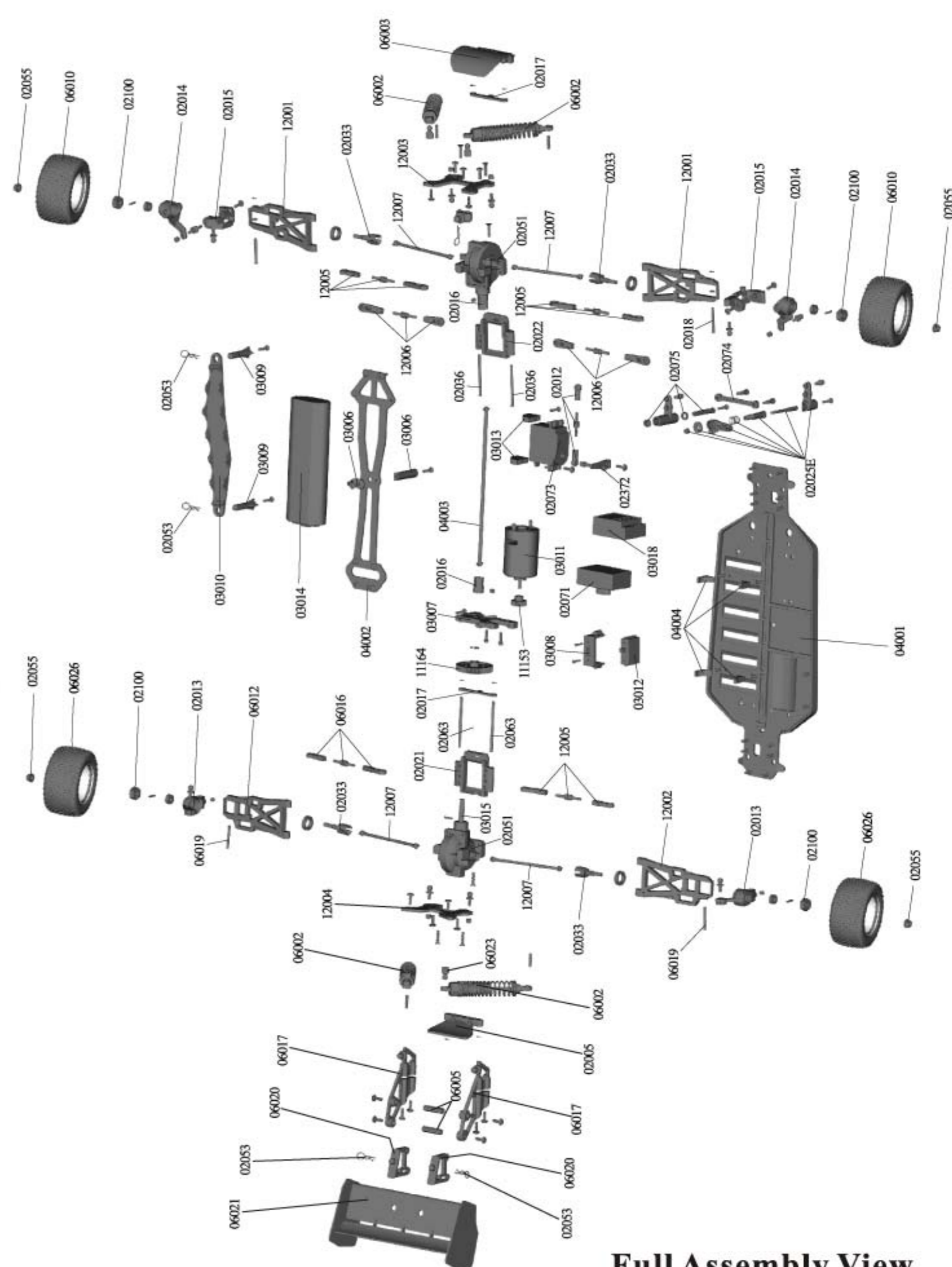

























The actual received parts may vary from the images!

Optional parts are subject to change without prior notice.

The images with ★ are still undeveloped and will come in near future.

Full Assembly View





17701-Wheel Rim 2P 	17702-Tyre 2P 	17703-Wheel Complete 2P 	17704-Shock Absorber 2P 
02005-Rear Bumper 	06016-Servo link 2P 	02013-Rear upright +set screws 2P 	02014-Steering hubs 2P 
02015-Front hub carrier 2P 	02016-Universal Joint Cup B 2P 	02017-Suspension reinforcement brace 2P 	02021-Rear suspension arm Holder 
02022-Front suspension arm Holder 	02024-Diff.gear complete 	08425E-Steering Assembly A 	02029-Diff.main gear 
02032-Universal Joint Cup C 	02033N-Steering Axle 	02036-Front Lower Arm Pin A 2P 	02037-E-Clip 12 pcs (Ø7. Ø4.Ø2.5.Ø2.3) 
02038-Ball Head Screw 6pcs 	02039-Diff. Box (with 2 Rings & Steel washers) 	02051-Gear Box 	02053-Body clip 8P 

02098-Grub screw M3*4 8P 	02099-Grub screw M4*4 8P 	02100-Wheel Hex. 8P 	02101-Steering bushing 
02102-M3 nylon locknut 6P 	02103-Zip Tie 6P 	02138-Rolling Bearing Ø15*Ø10*4 - 6pcs 	02139-Rolling Bearing Ø10*Ø5*4 - 8pcs 
08002-Front Bumper 	06007-Link ball head 4P 	08005-Front Lower Suspension Arm 2P 	08006-Rear Lower Suspension Arm 2P 
08007-Body post 4P 	08012-Shock Tower 	08019-Rear Lower Arm Pin B 2pcs 	08020-Front Lower Arm Pin B 2p cs 
08021-Shock Ball Head Holder 4P 	08024-Discal screw M3*10 8P 	08027-Pin 2*10 10P 	08029-Front/rear dogbone 88 mm 2P 
08042-Front/rear link 2P 	03006-Antenna Mount 	03007-Motor Mount 	03008-Switch Cover 

off-road ATV(G)-spare parts

off-road ATV(G)-upgradable optionals

03009- Battery cover post 	03010- Battery cover 	03020-Receiver 	Sp3001-Servo(3Kgs) 
03013- Radio tray holder 	03015- Drive shaft+ E-clip 	03018- Electronic Speed Controller 	03014-Battery Pack (7.2V 1800mA) 
04001- Chassis 	04002- Radio tray 	04003- Centre dogbone 	04004- Battery Corner Holder 
11164- Diff. Main Gear (64T) 	11120- Motor Gear (18T) 	08028-Bump Post 4P 	08032-Bumper spring 4P 
03300-Motor Heatproof Cover 	ATV1001-ATV body  <i>1/10th scale EP off road ATV body</i>	ATV1002-ATV body handle with mount and screws 	ATV1003-ATV rider w/ the mount post  <i>mount post</i>
08151-Tire Insert Sponge 2P 	03401-Gear Shelter New 		

102010-Aluminum Front Hub Carrier (L/R) 	102011-Aluminum Steering Hub(L/R) 	102012-Aluminum Rear Hub Carrier (L/R) 	102042-Aluminum Wheel Hex. Mount 4P 
102048-Aluminum Nut M3 8P 	102049-Aluminum Nut M4 4P 	106017-Aluminum Front/rear & Servo Link 2P 	108015-Universal Drive Joint 2P 
108019-Aluminum Front Lower Arm 2P 	108021-Aluminum Rear Lower Arm 2P 	108022-Aluminum Shock Tower 	108037-Aluminum Body Post 4P 
110004-Aluminum Shock Absorber 2P 	107050-Battery pack (7.2V,3000mAh) 	107051-Brushless Motor KV:3300  Taiwan	107052T-Brushless Electronic Speed Control 75A  Taiwan
03320- Fan-for ESC 	28446- Motor RC(550)  Taiwan	03028- Fail Safe  Taiwan	28435-Electronic speed controller 20T  Taiwan
28437-Electronic speed controller 15T  Taiwan	28430-Lithium battery Charger  Taiwan	28453-2CH CHARGER  Taiwan	28454-3Power Switch 

The actual received parts may vary from the images!

Optional parts are subject to change without prior notice.

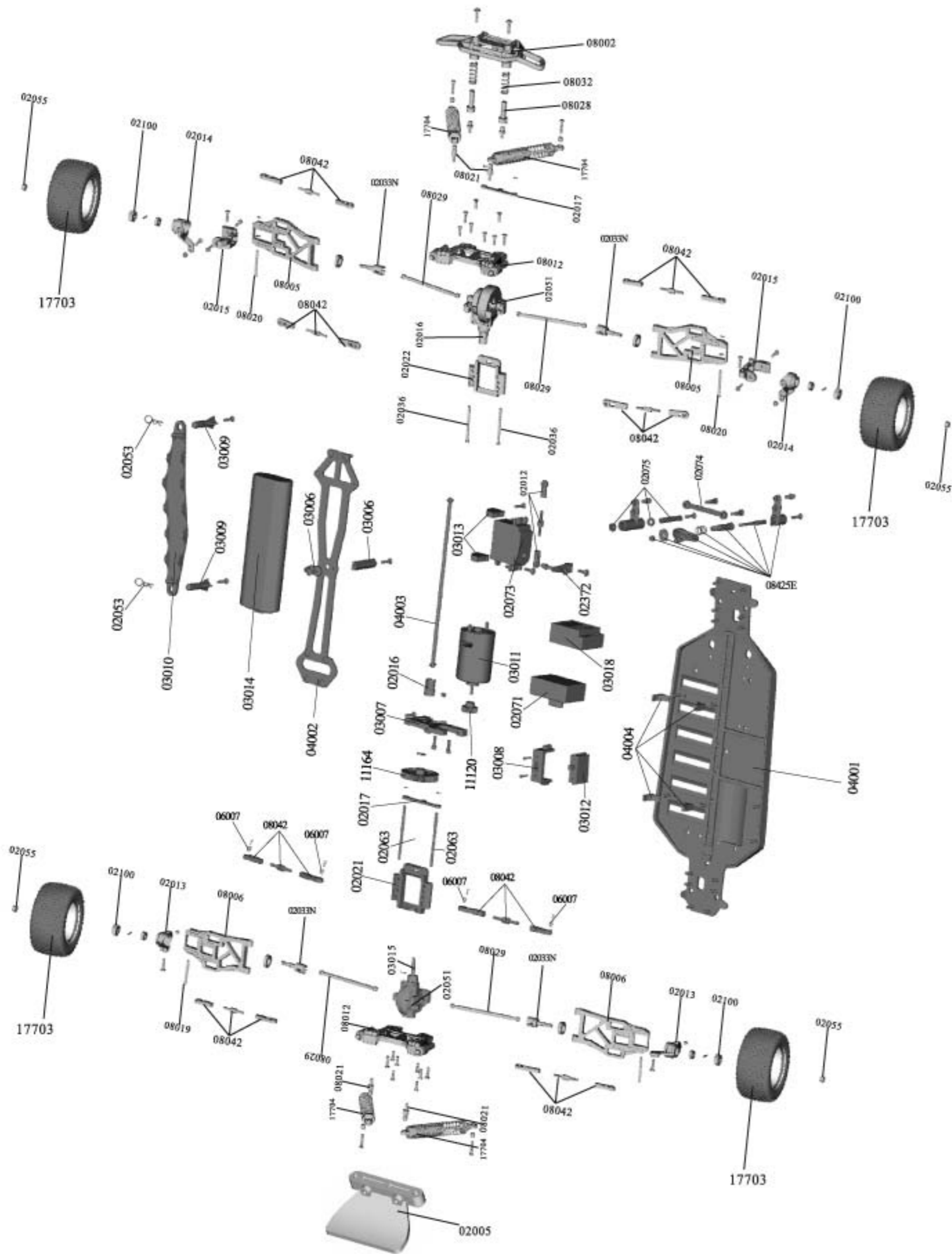

Full Assembly View

11164- Diff. Main Gear (64T)  A1/A2/E1/E2	11120- Motor Gear (18T)  A1/A2/E1/E2	11164- Diff. Main Gear (64T)  B1/B2/H1/H2	11120- Motor Gear (18T)  B1/B2/H1/H2	11164- Diff. Main Gear (64T)  C1/C2
11120- Motor Gear (18T)  C1/C2	11164- Diff. Main Gear (64T)  D1/D2	11120- Motor Gear (18T)  D1/D2	11164- Diff. Main Gear (64T)  F1/F2	11120- Motor Gear (18T)  F1/F2
11164- Diff. Main Gear (64T)  G	11120- Motor Gear (18T)  G			

The following are the optional motor gears which are available at factory.

11144- Motor Gear (14T) 	11146- Motor Gear (16T) 	11119- Motor Gear (17T) 	11149- Motor Gear (19T) 	11150- Motor Gear (20T) 
11151- Motor Gear (21T) 	11152- Motor Gear (22T) 	11153- Motor Gear (23T) 	03005- Motor Gear (26T) 	

Diff.Gear optional parts.

02024T-Diff.Main Gear Complete  NEW	02030T-Drive pinion complete  NEW	02051T- Gear Box  NEW		
---	---	-----------------------------	--	--